

**GRID CONNECTION CODE FOR *RENEWABLE POWER PLANTS (RPPs)* CONNECTED TO THE ELECTRICITY TRANSMISSION SYSTEM (TS) OR THE *DISTRIBUTION SYSTEM (DS)* IN SOUTH AFRICA**

**Version 2.8**

**(July 2014)**

**This document is approved by the National Energy Regulator  
of South Africa (NERSA)**

**Issued by:**

RSA Grid Code Secretariat  
**Contact: Mr. B. Magoro or Mr. T. Khoza**  
Eskom Transmission Division  
P.O Box 103, Germiston 1400  
Tell: +27 (0)11 871 2774 / 2368  
Fax: +27 (0)86 663 8418  
Email: [magorotb@eskom.co.za](mailto:magorotb@eskom.co.za) or  
[themba.khoza@eskom.co.za](mailto:themba.khoza@eskom.co.za)

## Table of Contents

<u>Paragraph No./Title</u>	<u>Page Number</u>
<b>1. Grid Connection Code Basis .....</b>	<b>5</b>
1.1 Legislation .....	5
1.2 Handling of Non-compliances and Deviations .....	5
<b>2. Objectives .....</b>	<b>5</b>
<b>3. Scope .....</b>	<b>5</b>
<b>4. Definitions and Abbreviations .....</b>	<b>7</b>
<b>5. Tolerance of Frequency and Voltage Deviations .....</b>	<b>12</b>
5.1 Normal Operating Conditions .....	12
5.1.1 Synchronising to the NIPS .....	14
5.2 Abnormal Operating Conditions .....	14
5.2.1 Tolerance to sudden voltage drops and peaks .....	15
<b>6. Frequency Response .....</b>	<b>18</b>
6.1 Power-frequency response curve for RPPs.....	18
6.2 Power-frequency response curve for RPPs of Category C.....	19
6.3 Procedure for setting and changing the power-frequency response curves for RPPs of Categories C .....	21
<b>7. Reactive Power Capabilities .....</b>	<b>21</b>
7.1 RPPs of Category A.....	21
7.2 RPPs of Category B.....	22
7.3 RPPs of Category C.....	24
<b>8. Reactive Power and Voltage Control Functions.....</b>	<b>26</b>
8.1 Reactive power (Q) Control .....	26
8.2 Power Factor Control .....	27
8.3 Voltage Control .....	27
<b>9. Power Quality .....</b>	<b>28</b>
<b>10. Protection and Fault levels .....</b>	<b>30</b>
<b>11. Active Power Constraint Functions .....</b>	<b>31</b>
11.1 Absolute Production Constraint .....	31
11.2 Delta Production Constraint.....	32
11.3 Power Gradient Constraint .....	32
<b>12. Control Function Requirements .....</b>	<b>33</b>
<b>13. Signals, Communications &amp; Control.....</b>	<b>34</b>
13.1 Signals from the RPP available at the POC .....	34
13.1.1 Signals List #1 – General.....	35
13.1.2 Signals List #2 – RPP Availability Estimates.....	35
13.1.3 Signals List #3 – RPP MW Curtailment Data .....	35
13.1.4 Signals List #4 – Frequency Response System Settings.....	36
13.1.5 Signals List #5 – RPP Meteorological Data. ....	36
13.2 Update Rates.....	37
13.3 Control Signals Sent from SO to the RPPs.....	37
13.3.1 Active-Power Control .....	37
13.3.2 Connection Point CB Trip facility.....	37
13.4 MW Forecast .....	37
13.5 RPP MW availability declaration .....	38
13.6 Data Communications Specifications .....	38
<b>14. Testing and Compliance Monitoring.....</b>	<b>39</b>

<b>15. Reporting to NERSA.....</b>	<b>40</b>
<b>16. Provision of Data and Electrical Dynamic Simulation Models .....</b>	<b>41</b>
<b>Appendices.....</b>	<b>44</b>
<b>Appendix 1 - Wind .....</b>	<b>45</b>
<i>A1.1 High Wind Curtailment.....</i>	<i>45</i>
<b>Appendix 2 - Photovoltaic .....</b>	<b>46</b>
<b>Appendix 3 - Concentrated Solar Power.....</b>	<b>47</b>
<b>Appendix 4 - Small Hydro.....</b>	<b>48</b>
<b>Appendix 5 - Landfill Gas .....</b>	<b>49</b>
<b>Appendix 6 - Biomass.....</b>	<b>50</b>
<b>Appendix 7 - Biogas.....</b>	<b>51</b>
<b>Appendix 8 - Documentation .....</b>	<b>52</b>
<i>A8.1 Master Data .....</i>	<i>52</i>
<i>A8.2 Technical Documentation .....</i>	<i>54</i>
<i>A8.2.2 Single Line Diagram Representation .....</i>	<i>55</i>
<i>A8.2.3 PQ Diagram .....</i>	<i>55</i>
<i>A8.2.4 Short-circuit data.....</i>	<i>55</i>
<b>Appendix 9 – Compliance test specifications .....</b>	<b>58</b>

## **1. Grid Connection Code Basis**

### **1.1 Legislation**

(1) The legal basis for this grid connection code is specified in terms of the Electricity Regulation Act (Act 4 of 2006), as amended.

(2) This *Grid Connection Code for Renewable Power Plants (RPPs) connected to the electricity Transmission System (TS) or the Distribution System (DS) in South Africa* has, on the date of approval by NERSA, superseded the *Grid Code Requirements for Wind Energy Facilities Connected to the Distribution or Transmission Systems in South Africa*.

### **1.2 Handling of Non-compliances and Deviations**

(1) Amendments, derogations or exemptions shall be processed as specified in the RSA Grid Code, as amended.

## **2. Objectives**

(1) The primary objective of this grid connection code is to specify minimum technical and design grid connection requirements for *Renewable Power Plants (RPPs)* connected to or seeking connection to the South African electricity *transmission system (TS)* or *distribution system (DS)*.

(2) This document shall be used together with other applicable requirements of the *code* (i.e. the Grid Code, the Distribution Code and the *Scheduling and Dispatch Rules*), as compliance criteria for *RPPs* connected to the *TS* and the *DS*.

## **3. Scope**

(1) The grid connection requirements in this code shall apply to all *RPPs* connected or seeking connection to the *TS* or *DS*, *the SO*, as well as to the respective electrical *Network Service Providers (NSPs)*.

(2) This grid connection code shall, at minimum, apply to the following *RPP* technologies:

- (a) Photovoltaic
- (b) Concentrated Solar Power
- (c) Small Hydro
- (d) Landfill gas
- (e) Biomass
- (f) Biogas
- (g) Wind

(3) All thermal *RPPs* and hydro *units* of category C (as defined in paragraph (7) below) shall also comply with the design requirements specified in the SA Grid Code (specifically section 3.1. of the Network Code). This *RPP* grid connection code shall take precedence whenever there is a conflict between this code and other *codes*.

(4) Unless otherwise stated, the requirements in this grid connection code shall apply equally to all *RPP* technologies and *categories*.

(5) The *RPP* shall, for duration of its generation licence issued by *National Energy Regulator of South Africa (NERSA)*, comply with the provisions of this grid connection code and all other applicable codes, rules and regulations approved by *NERSA*.

(6) Where there has been a replacement of or a major modification to an existing *RPP*, the *RPP* shall be required to demonstrate compliance to these requirements before being allowed to operate commercially.

(7) Compliance with this grid connection code shall be applicable to the *RPP* depending on its *rated power* and, where indicated, the nominal voltage at the *POC*. Accordingly, *RPPs* are grouped into the following three categories:

**(a) Category A: 0 – 1 MVA (Only LV connected RPPs)**

This category includes *RPPs* with *rated power* of less than 1 MVA and connected to the *LV* voltage (typically called 'small or micro turbines'). This category shall further be divided into 3 sub-categories:

**(i) Category A1: 0 - 13.8 kVA**

This sub-category includes *RPPs* of *Category A* with *rated power* in the range of 0 to 13.8 kVA.

**(ii) Category A2: 13.8 kVA – 100 kVA**

This sub-category includes *RPPs* of *Category A* with *rated power* in the range greater than 13.8 kVA but less than 100 kVA.

**(iii) Category A3: 100 kVA – 1 MVA**

This sub-category includes *RPPs* of *Category A* with *rated power* in the range 100 kVA but less than 1 MVA.

This category also includes *RPPs* of *Category A1* and *A2* with a *rated power* less than 100kVA that are directly connected to a MV-LV transformer.

**Note:** *RPPs* with a *rated power* greater than 4.6 kVA must be balanced three-phase.

**(b) Category B: 1 MVA – 20 MVA and RPPs less than 1 MVA connected to the MV**

This category includes *RPPs* with *rated power* in the range equal or greater than 1 MVA but less than 20 MVA and *RPPs* with *rated power* less than 1 MVA connected to the *MV*.

**(c) Category C: 20 MVA or higher**

This category includes *RPPs* with *rated power* equal to or greater than 20 MVA.

(8) The requirements of this *grid connection code* are organized according to above defined categories. Unless otherwise stated, requirements in this *grid connection code* shall apply equally to all *categories* of *RPPs*.

(9) Compliance with this and other *codes* requirements will depend on the interaction between the *RPP* and the grid to which it is connected. The *NSP* shall supply the *RPP Generator* with a reasonable detail of their *TS* or *DS* that is sufficient to allow an accurate analysis of the interaction between the *RPP* and the *NIPS*, including other *generation facilities*.

## **4. Definitions and Abbreviations**

(1) Unless otherwise indicated, words and terminology in this document shall have the same meaning as those in the *codes*. The following definitions and abbreviations are used in this document.

### **Active Power Curtailment Set-point**

The limit set by the *SO*, *NSP* or their agent for the amount of active power that the *RPP* is permitted to generate. This instruction may be issued manually or automatically via a tele-control facility. The manner of applying the limitation shall be agreed between the parties.

### **Available Active Power**

The amount of active power (MW), measured at the *POC*, that the *RPP* could produce based on plant availability as well as current renewable primary energy conditions (e.g. wind speed, solar radiation).

### **Code**

The Distribution Code, the Transmission Grid Code or any other Code, approved by *NERSA*.

### **Connection Agreement**

As defined in the *Code*,

**Communication Gateway Equipment**

As defined in the *Code*,

**Curtailed Active Power**

The amount of Active Power that the *RPP* is permitted to generate by the *SO*, *NSP* or their agent subject to network or system constraints.

**Distribution System (DS)**

As defined in the *Code*

**Distributor**

As defined in the *Code*

**Droop**

A percentage of the frequency change required for an *RPP* to move from no-load to *rated power* or from *rated power* to no-load.

**Extra High Voltage (EHV)**

The set of nominal voltage levels greater than 220 kV.

**Frequency control**

The control of active power with a view to stabilising frequency of the *NIPS*.

**Generator**

As defined in the *Code*

**High voltage (HV)**

The set of nominal voltage levels greater than 33 kV up to and including 220 kV.

**Low voltage (LV)**

Nominal voltage levels up to and including 1 kV.

**Maximum voltages ( $U_{max}$ )**

Maximum continuous operating voltage

**Medium voltage (MV)**

The set of nominal voltage levels greater than 1 kV up to and including 33 kV.

**Minimum voltages ( $U_{min}$ )**

Minimum continuous operating voltage



**National Energy Regulator of South Africa (NERSA)**

The legal entity established in terms of the National Energy Regulator Act, 2004 (Act 40 of 2004), as amended.

**National Interconnected Power Systems (NIPS)**

The electrical network comprising components that have a measurable influence on each other as they are operating as one system, this includes:

- the *TS*;
- the *DS*;
- assets connected to the *TS* and *DS*;
- *power stations* connected to the *TS* and *DS*;
- international *interconnectors*;
- the *control area* for which the *SO* is responsible.

**National Transmission Company (NTC)**

As defined in the *Code*

**Network Service Provider (NSP)**

As defined in the *Code*

**Nominal voltage**

The voltage for which a network is defined and to which operational measurements are referred.

**Participants**

As defined in the *Code*,

**Point of Common Coupling (PCC)**

As defined in the *Code*,

**Point of Connection (POC)**

As defined in the *Code*

**Power Quality**

Characteristics of the electricity at a given point on an electrical system, evaluated against a set of reference technical parameters. These characteristics include:

- voltage or current quality, i.e. regulation (magnitude), harmonic distortions, flicker, unbalance;
- voltage events, i.e. voltage dips, voltage swells, voltage transients;

- (supply) interruptions;
- frequency of supply.

### **Rated power (of the RPP)**

The highest active power measured at the *POC*, which the *RPP* is designed to continuously supply.

### **Rated wind speed**

The average wind speed at which a *wind power plant* achieves its *rated power*. The average renewable speed is calculated as the average value of renewable speeds measured at hub height over a period of 10 minutes.

### **Renewable Power Plant (RPP)**

One or more *unit(s)* and associated equipment, with a stated *rated power*, which has been connected to the same *POC* and operating as a single power plant.

#### **Notes:**

It is therefore the entire RPP that shall be designed to achieve requirements of this code at the *POC*. A *RPP* has only one *POC*.

In this *code*, the term *RPP* is used as the umbrella term for a *unit* or a system of generating *units* producing electricity based on a primary renewable energy source (e.g. wind, sun, water, biomass etc.). A *RPP* can use different kinds of primary energy source. If a *RPP* consists of a homogeneous type of generating *units* it can be named as follows:

- **PV Power Plant (PVPP)**  
A single photovoltaic panel or a group of several photovoltaic panels with associated equipment operating as a power plant.
- **Concentrated Solar Power Plant (CSPP)**  
A group of aggregates to concentrate the solar radiation and convert the concentrated power to drive a turbine or a group of several turbines with associated equipment operating as a power plant.
- **Small Hydro Power Plant (SHPP)**  
A single hydraulic driven turbine or a group of several hydraulic driven turbines with associated equipment operating as a power plant.
- **Landfill Gas Power Plant (LGPP)**  
A single turbine or a group of several turbines driven by landfill gas with associated equipment operating as a power plant.

- **Biomass Power Plant (BMPP)**

A single turbine or a group of several turbines driven by biomass as fuel with associated equipment operating as a power plant.

- **Biogas Power Plant (BGPP)**

A single turbine or a group of several turbines driven by biogas as fuel with associated equipment operating as a power plant.

- **Wind Power Plant (WPP)**

A single turbine or a group of several turbines driven by wind as fuel with associated equipment operating as a power plant. This is also referred to as a wind energy facility (WEF)

### **Renewable Power Plant (RPP) Controller**

A set of control functions that make it possible to control the *RPP* at the *POC*. The set of control functions shall form a part of the *RPP*.

### **RPP Generator**

Means a legal entity that is licensed to develop and operate a *RPP*.

### **System Operator (SO)**

As defined in the *Code*

### **Transmission Network Service Provider (TNSP)**

As defined in the *Code*

### **Transmission System (TS)**

As defined in the *Code*

### **Unit / Generation facility**

As defined in the *Code*

### **Voltage Quality**

Subset of *power quality* referring to steady-state voltage quality, i.e. voltage regulation (magnitude), voltage harmonics, voltage flicker, voltage unbalance, voltage dips. The current drawn from or injected into the *POC* is the driving factor for voltage quality deviations.

### Voltage Ride Through (VRT) Capability

Capability of the *RPP* to stay connected to the network and keep operating following voltage dips or surges caused by short-circuits or disturbances on any or all phases in the *TS* or *DS*.

## 5. Tolerance of Frequency and Voltage Deviations

- (1) The *RPP* shall be able to withstand frequency and voltage deviations at the *POC* under normal and abnormal operating conditions described in this grid connection code while reducing the active power as little as possible.
- (2) The *RPP* shall be able to support network frequency and voltage stability in line with the requirements of this grid connection code.
- (3) Normal operating conditions and abnormal operating conditions are described in section 5.1 and section 5.2, respectively.

### 5.1 Normal Operating Conditions

- (1) Unless otherwise stated, requirements in this section shall apply to all *categories* of *RPPs*.
- (2) *RPPs* of *Category A* shall be designed to be capable of operating continuously within the voltage range of -15% to +10% around the nominal voltage at the *POC*. The actual operating voltage differs from location to location, and this shall be decided by the *NSP* in consultation with the affected *customers* (including the *RPP generator*), and implemented by the *RPP generator*.
- (3) *RPPs* of *Category B and C* shall be designed to be capable of operating continuously within the *POC* voltage range specified by *Umin* and *Umax* as shown in table 1 below, measured at the *POC*. The actual operating voltage differs from location to location, and this shall be decided by the *NSP* in consultation with the affected *customers* (including the *RPP generator*), and implemented by the *RPP generator*.

**Table 1: Minimum and maximum operating voltages at POC**

Nominal (Un) [kV]	Umin [pu]	Umax [pu]
132	0.90	1.0985
88	0.90	1.0985
66	0.90	1.0985
44	0.90	1.08
33	0.90	1.08
22	0.90	1.08
11	0.90	1.08

- (4) The nominal frequency of the *National Integrated Power System (NIPS)* is 50 Hz and is normally controlled within the limits as defined in the *Grid Code*. The *RPP* shall be designed

to be capable of operating for the minimum operating range illustrated in Figures 1 (total cumulative over the life of the *RPP*) and Figure 2 (during a system frequency disturbance).

(5) When the frequency on the *NIPS* is higher than 51.5 Hz for longer than 4 seconds, the *RPP* shall be disconnected from the grid.

(6) When the frequency on the *NIPS* is less than 47.0 Hz for longer than 200ms, the *RPP* may be disconnected.

(7) The *RPP* shall remain connected to the *NIPS* during rate of change of frequency of values up to and including 1.5 Hz per second, provided the network frequency is still within the minimum operating range indicated in Figures 1 and 2.

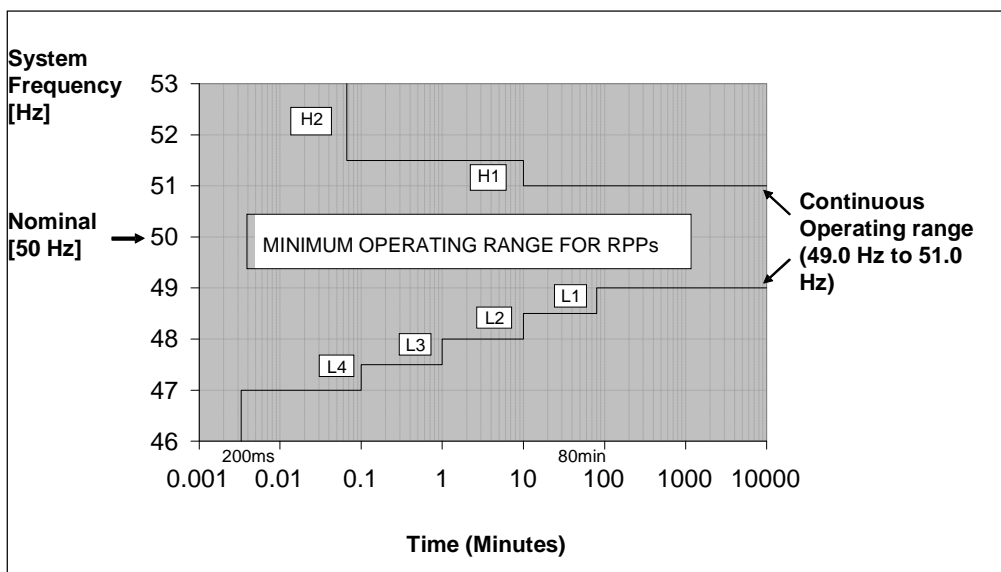

**Figure 1: Minimum frequency operating range for *RPP* (Cumulative over the life of the *RPP*)**

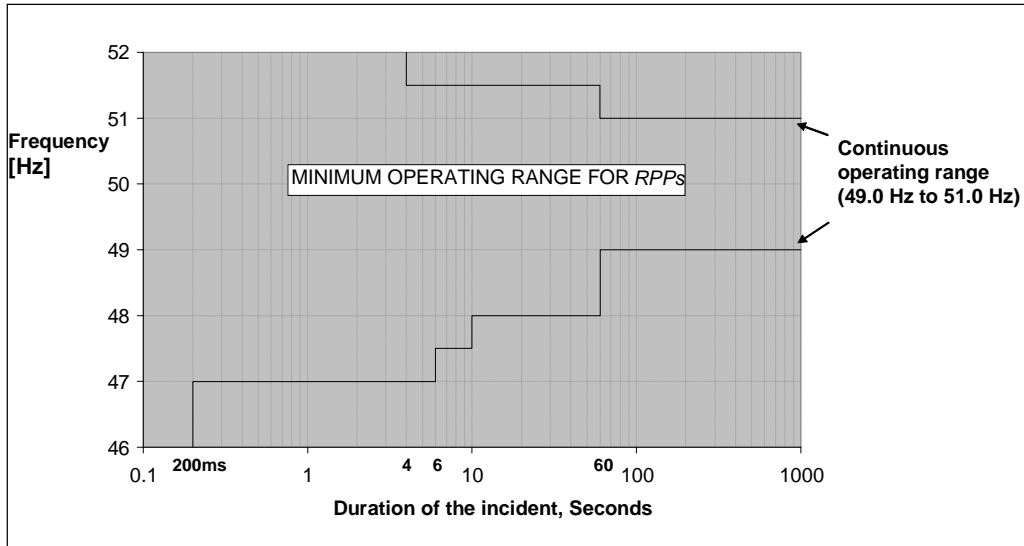

**Figure 2: Minimum *frequency* operating range of a *RPP* (during a system *frequency* disturbance)**

### 5.1.1 Synchronising to the *NIPS*

(1) *RPPs* of *Category A* shall only be allowed to connect to the *NIPS*, at the earliest, 60 seconds after:

- (a) The voltage at the *POC* is in the range -15% to +10% around the *nominal voltage*,
- (b) Frequency in the *NIPS* is within the range of 49.0Hz and 50.2Hz, or otherwise as agreed with the *SO*.

(2) *RPPs* of *Category B* and *C* shall only be allowed to connect to the *NIPS*, at the earliest, 3 seconds after:

- (a) (for *TS* connected *RPPs*), the voltage at the *POC* is within  $\pm 5\%$  around the *nominal voltage*,
- (b) (for *DS* connected *RPPs*), the voltage at the *POC* is within  $U_{max}$  and  $U_{min}$ , as specified in Table 1, around the *nominal voltage*,
- (c) frequency in the *NIPS* is within the range of 49.0Hz and 50.2Hz, or otherwise as agreed with the *SO*.

## 5.2 Abnormal Operating Conditions

(1) The *RPP* shall be designed to withstand sudden phase jumps of up to  $20^\circ$  at the *POC* without disconnecting or reducing its output. The *RPP* shall after a settling period resume normal production not later than 5 sec after the operating conditions in the *POC* have reverted to the normal operating conditions.

### 5.2.1 Tolerance to sudden voltage drops and peaks

#### (a) RPPs of Category A1 and A2

(1) RPPs of Categories A1 and A2 shall be designed to withstand and fulfil, at the POC, voltage ride through conditions illustrated in Figure 3 below.

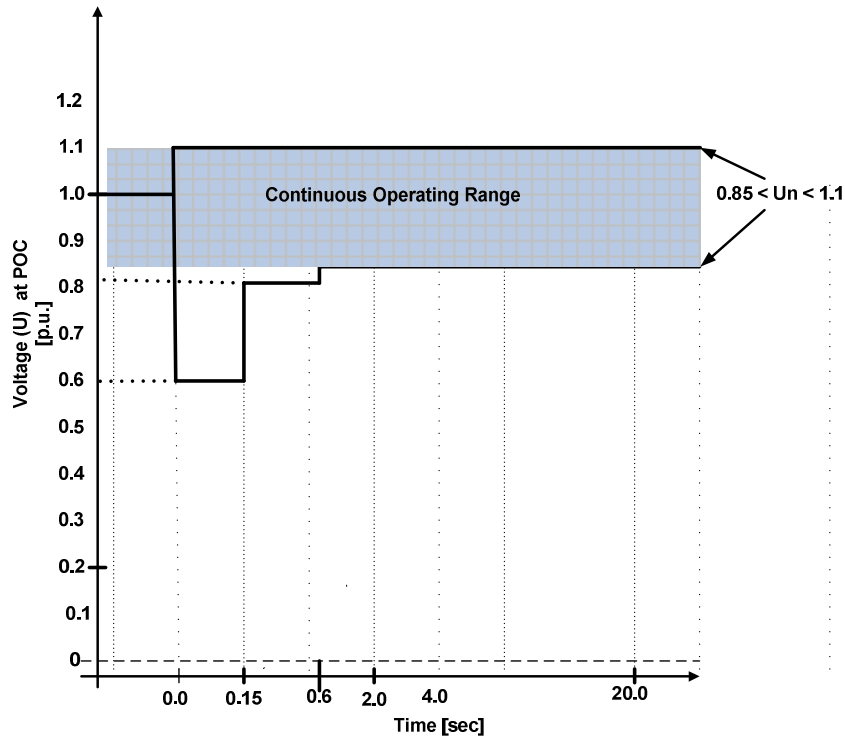

Figure 3: Voltage Ride Through Capability for the RPPs of Category A1 and A2

(2) In addition, the maximum disconnection times for RPPs of Category A1 and A2 is given in Table 2 below.

Table 2: Maximum disconnection times for RPPs of Categories A1 and A2.

Voltage range (at the POC)	Maximum trip time [Seconds]
$V < 50 \%$	0,2 s
$50 \% \leq V < 85 \%$	2 s
$85 \% \leq V \leq 110 \%$	Continuous operation
$110 \% < V < 120 \%$	2 s
$120 \% \leq V$	0,16 s

#### (b) RPPs of Categories A3, B and C

(1) RPPs of Categories A3, B and C shall be designed to withstand and fulfil, at the POC, voltage conditions described in this section and illustrated in Figures 4 and 5 below. The Area D is only applicable to category C RPPs.

- (2) The *RPP* shall be designed to withstand voltage drops and peaks, as illustrated in Figure 4 and supply or absorb reactive current as illustrated in Figure 5 without disconnecting.
- (3) The *RPP* shall be able to withstand voltage drops to zero, measured at the *POC*, for a minimum period of 0.150 seconds without disconnecting, as shown in Figure 4.
- (4) The *RPP* of category *C* shall be able to withstand voltage peaks up to 120% of the nominal voltage, measured at the *POC*, for a minimum period of 2 seconds without disconnecting, as shown in Figure 4.
- (5) Figure 4 shall apply to all types of faults (symmetrical and asymmetrical i.e. one-, two- or three-phase faults) and the bold line shall represent the minimum voltage of all the phases.

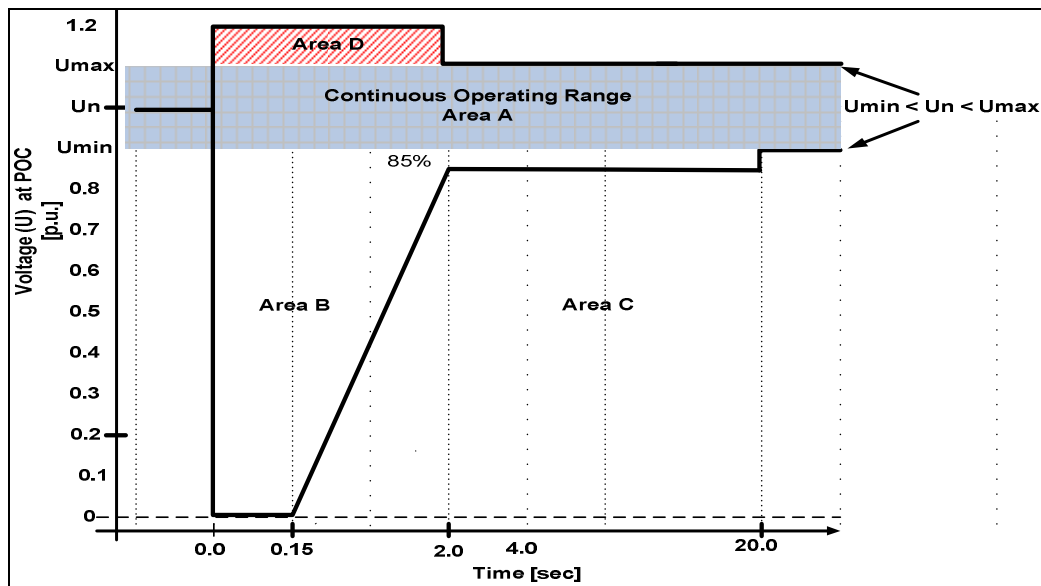

**Figure 4: Voltage Ride Through Capability for the *RPPs* of Category A3, B and C**

- (6) If the voltage (*U*) reverts to area A during a fault sequence, subsequent voltage drops shall be regarded as a new fault condition. If several successive fault sequences occur within area B and evolve into area C, disconnection is allowed, see Figure 4.
- (7) In the area C (Figure 4): disconnection of the *RPP* is allowed.
- (8) In connection with symmetrical fault sequences in areas B and D of Figure 4, the *RPP* (other than synchronous generating units) shall have the capability of controlling the reactive current, as illustrated in Figure 5. The following requirements shall be complied with:
- (a) **Area A:** The *RPP* shall stay connected to the network and uphold normal production.
  - (b) **Area B:** The *RPP* shall stay connected to the network and in addition:



(i) *RPPs* of *category A3* shall not inject any reactive current into the network;

(ii) *RPPs* of *category B* and *category C* shall provide maximum voltage support by supplying a controlled amount of reactive current so as to ensure that the *RPP* assists in stabilising the voltage as shown in Figure 5.

(iii) Inverter driven *RPPs* of *category B* and *category C* shall be able to disable reactive current support functionality at the request of *SO* or local network operator.

**(c) Area D:** The *RPP* shall stay connected to the network and provide maximum voltage support by absorbing a controlled amount of reactive current so as to ensure that the *RPP* helps to stabilise the voltage within the design capability offered by the *RPP*, see Figure 5.

**(d) Area E (Figure 5):** Once the voltage at the *POC* is below 20%, the *RPP* shall continue to supply reactive current within its technical design limitations so as to ensure that the *RPP* helps to stabilise the voltage. Disconnection is only allowed after conditions of Figure 4 have been fulfilled.

(9) Control shall follow Figure 5 so that the reactive current follows the control characteristic with a tolerance of  $\pm 20\%$  after 60 ms.

(10) The supply of reactive power has first priority in area B, while the supply of active power has second priority. Active power shall be maintained during voltage drops, but a reduction in active power within the *RPP's* design specifications is required in proportion to voltage drop for voltages below 85%.

(11) Upon clearance of fault each *RPP* shall restore active power production to at least 90% of the level available immediately prior to the fault within 1 second.

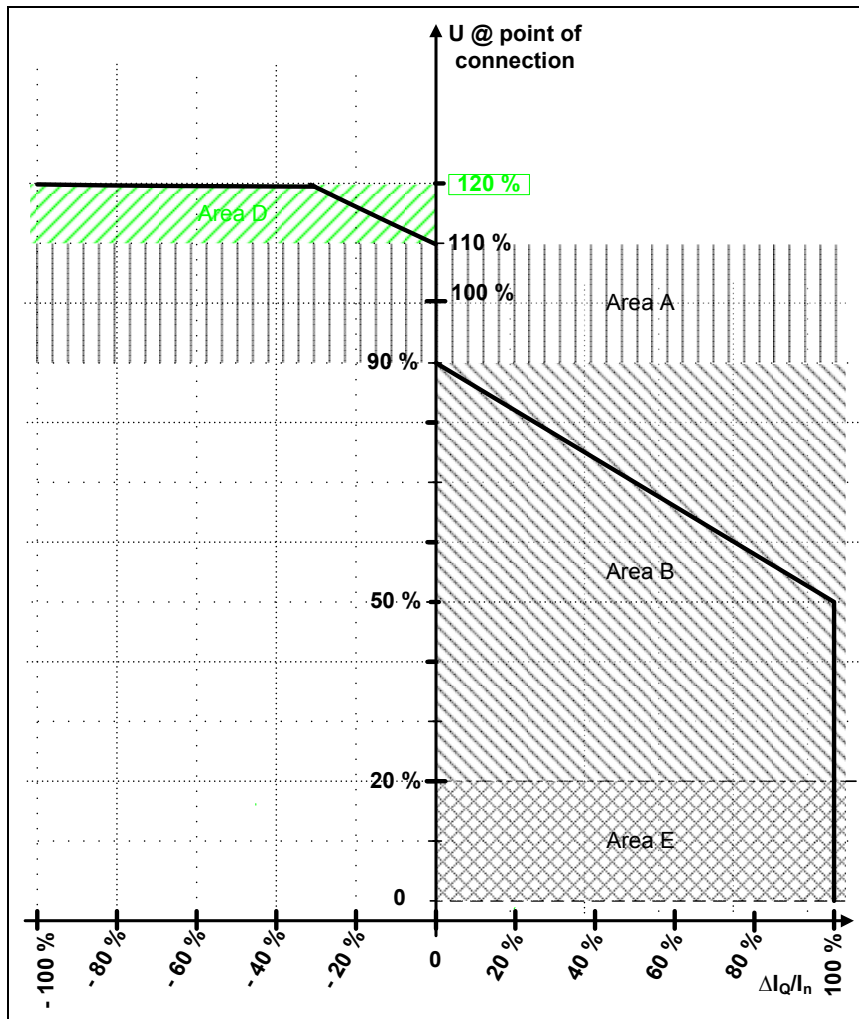

Figure 5: Requirements for Reactive Power Support,  $I_Q$ , during voltage drops or peaks at the POC

## 6. Frequency Response

(1) In case of frequency deviations in the *NIPS*, *RPPs* shall be designed to be capable to provide power-frequency response in order to stabilise the grid *frequency*.

### 6.1 Power-frequency response curve for *RPPs*

(1) During high *frequency* operating conditions, *RPPs* shall be able to provide mandatory *active power* reduction requirement in order to stabilise the *frequency* in accordance with Figure 6 below. The metering accuracy for the grid *frequency* shall be  $\pm 10$  mHz or better.

(2) When the *frequency* on the *NIPS* exceeds 50.5 Hz, the *RPP* shall reduce the active power as a function of the change in *frequency* as illustrated in Figure 6 below.

(3) Once the frequency exceed 52Hz for longer than 4 seconds the RPP shall be tripped to protect the NIPS.

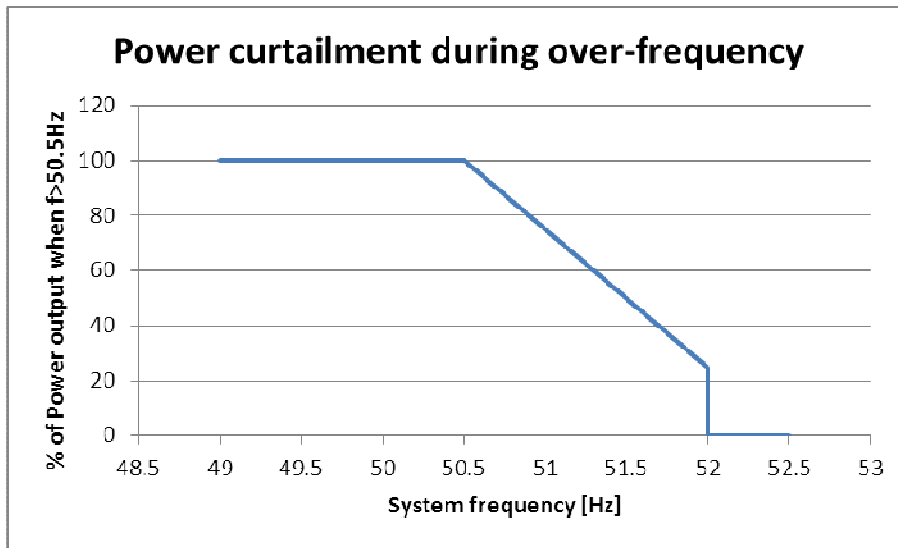

Figure 6: Power curtailment during over-frequency for RPPs

## 6.2 Power-frequency response curve for RPPs of Category C

(1) RPPs shall be designed to be capable to provide power-frequency response as illustrated in Figure 7.

(2) Except for the mandatory high frequency response (above 50.5 Hz), the RPP shall not perform any frequency response function (i.e. there shall be no  $P_{\Delta}$ , dead-band and control-band functions implement) without having entered into a specific agreement with the SO.

(3) It shall be possible to set the frequency response control function for all frequency points shown in Figure 7. It shall be possible to set the frequencies  $f_{\min}$ ,  $f_{\max}$ , as well as  $f_1$  to  $f_6$  to any value in the range of 47 - 52 Hz with a minimum accuracy of 10 mHz.

(4) The purpose of frequency points  $f_1$  to  $f_4$  is to form a dead band and a control band for for RPPs contracted for primary frequency response. The purpose of frequency points  $f_4$  to  $f_6$  is to supply mandatory critical power/frequency response.

(5) The RPP shall be equipped with the frequency control droop settings as illustrated in figure 7. Each droop setting shall be adjustable between 0% and 10%. The actual droop setting shall be as agreed with the SO.

(6) The SO shall decide and advise the RPP generator (directly or through its agent) on the droop settings required to perform control between the various frequency points.

(7) If the active power from the *RPP* is regulated downward below the unit's design limit  $P_{min}$ , shutting-down of individual *RPP units* is allowed.

(8) The *RPP* (with the exception of *RPPPV*) shall be designed with the capability of providing a  $P_{Delta}$  of not less than 3% of  $P_{available}$ .  $P_{Delta}$  is the amount of active power by which the available active power has been reduced in order to provide reserves for frequency stabilisation.

(9) It shall be possible to activate and deactivate the frequency response control function in the interval from  $f_{min}$  to  $f_{max}$ .

(10) If the frequency control setpoint ( $P_{Delta}$ ) is to be changed, such change shall be commenced within two seconds and completed no later than 10 seconds after receipt of an order to change the setpoint.

(11) The accuracy of the control performed (i.e. change in active power output) and of the setpoint shall not deviate by more than  $\pm 2\%$  of the setpoint value or by  $\pm 0.5\%$  of the rated power, depending on which yields the highest tolerance.

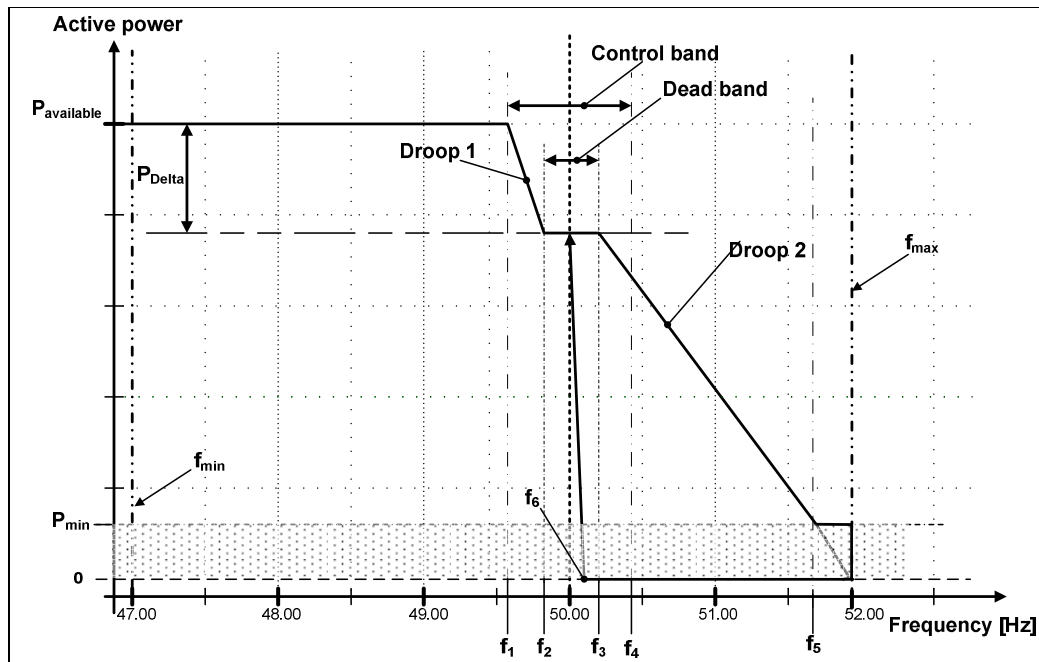

Figure 7: Frequency response requirement for *RPPs* of category C

(12) The default settings for  $f_{\min}$ ,  $f_{\max}$ ,  $f_4$ ,  $f_5$  and  $f_6$  shall be as shown in **Table 2**, unless otherwise agreed upon between the *SO* and the *RPP generator*. Settings for  $f_1$ ,  $f_2$  and  $f_3$  shall be as agreed with the *SO*.

**Table 2: Frequency Default Settings**

Parameter	Magnitude (Hz.)
$f_{\min}$	47
$f_{\max}$	52
$f_1$	As agreed with <i>SO</i>
$f_2$	As agreed with <i>SO</i>
$f_3$	As agreed with <i>SO</i>
$f_4$	50.5
$f_5$	51.5
$f_6$	50.2

### 6.3 Procedure for setting and changing the power-frequency response curves for *RPPs of Categories C*

(1) The *SO* or its agent shall give the *RPP generator* a minimum of 2 weeks if changes to any of the frequency response parameters (i.e.  $f_1$  to  $f_6$ ) are required. The *RPP generator* shall confirm with the *SO* or its agent that requested changes have been implemented within two weeks of receiving the *SO's* request.

## 7. Reactive Power Capabilities

### 7.1 *RPPs of Category A*

(1) *RPPs* of category A1 & A2 shall operate at unity power factor measured at *POC*, unless otherwise specified by the *NSP* or the *SO*.

(2) *RPPs* of category A3 shall be designed with the capability to supply *rated power* ( $P_n$ ) (MW) for power factors ranging between 0.95 lagging and 0.95 leading, measured at the *POC* available from 20% to 100% of *rated power* ( $P_n$ ).

(3) The *RPP* shall be designed to operate according to a power factor characteristic curve, which will be determined by the *NSP* or the *SO*.

(4) The default power factor setting shall be **unity** power factor, unless otherwise specified by the *NSP* or the *SO*.

## 7.2 RPPs of Category B

- (1) RPPs of category B shall be designed with the capability to operate in a voltage (V), power factor or reactive power (Q or Mvar) control modes as described in section 8 below. The actual operating mode (V, power factor or Q control) as well as the operating point shall be agreed with the NSP.
- (2) When operating between 5% and 100% of rated power  $P_n$  (MW) the RPP of category B shall have the capability of varying reactive power (Mvar) support at the POC within the reactive power capability ranges as defined by Figure 8a, where  $Q_{min}$  and  $Q_{max}$  are voltage dependent as defined by Figure 9.
- (3) At nominal voltage, the required RPP reactive power capability (measured at the POC) shall be as shown in Figure 8b.
- (4) When operating below 5% of rated power  $P_n$  (MW), there is no reactive power capability requirement, however the RPP can only operate within the reactive power tolerance range not exceeding  $\pm 5\%$  of rated power, that is within Area A,B,C and D in Figure 8b.

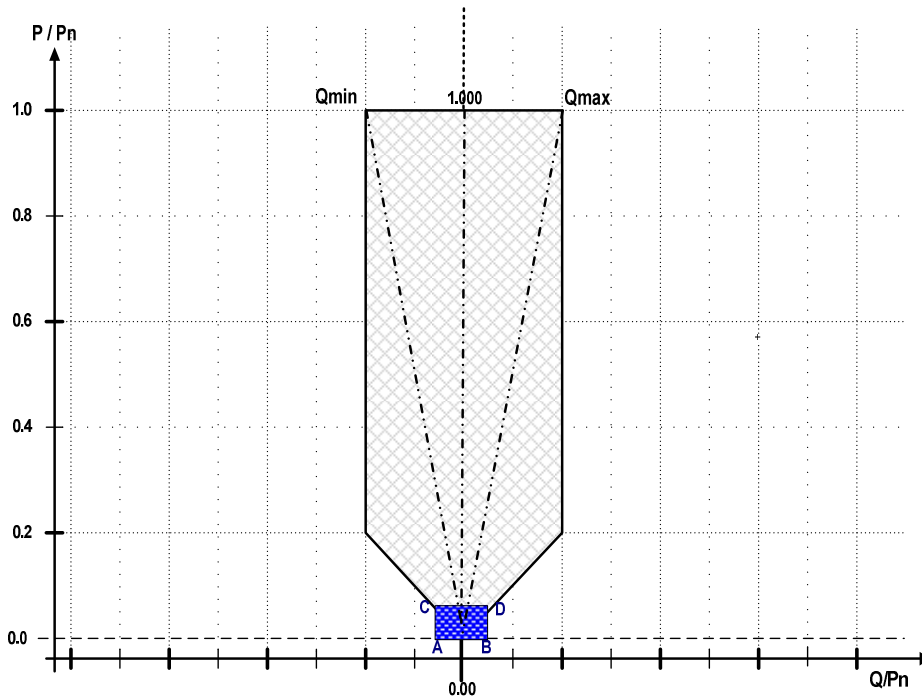

Figure 8a: Reactive power requirements for RPPs of category B at the POC ( $Q_{min}$  and  $Q_{max}$  are voltage dependent as defined by Figure 9)

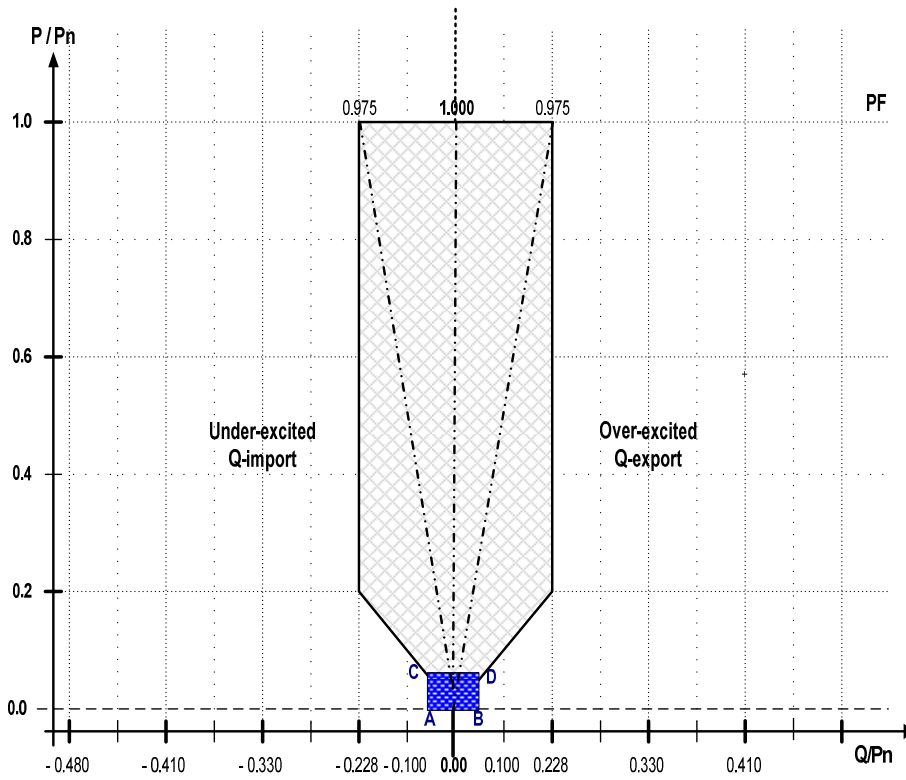

Figure 8b: Reactive power requirements for RPPs of category B (at nominal voltage at POC)

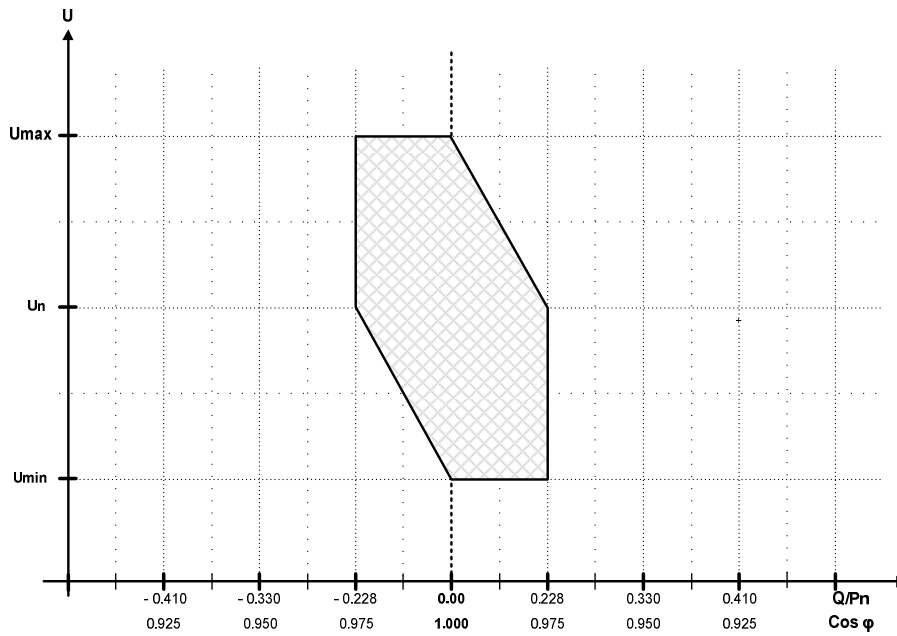

Figure 9: Requirements for reactive power and voltage control range for RPPs of category B.

### 7.3 RPPs of Category C

- (1) RPPs of category C shall be designed with the capability to operate in a voltage, power factor or, reactive power (Q or Mvar) control modes. The actual control operating mode (V, power factor or Q control) as well as operating point shall be agreed with the NSP.
- (2) When operating between 5% and 100% of rated power  $P_n$  (MW) the RPP of category C shall have the capability of varying reactive power (Mvar) support at the POC within the reactive power capability ranges as defined by Figure 10a, where  $Q_{min}$  and  $Q_{max}$  are voltage dependent as defined by Figure 11.
- (3) At nominal voltage, the required RPP reactive power capability (measured at the POC) shall be as shown in Figure 10b.
- (4) When operating below 5% of rated power  $P_n$  (MW), there is no reactive power capability requirement, however the RPP can only operate within the reactive power tolerance range not exceeding +5% of rated power, that is within Area A,B,C and D in Figure 10b.

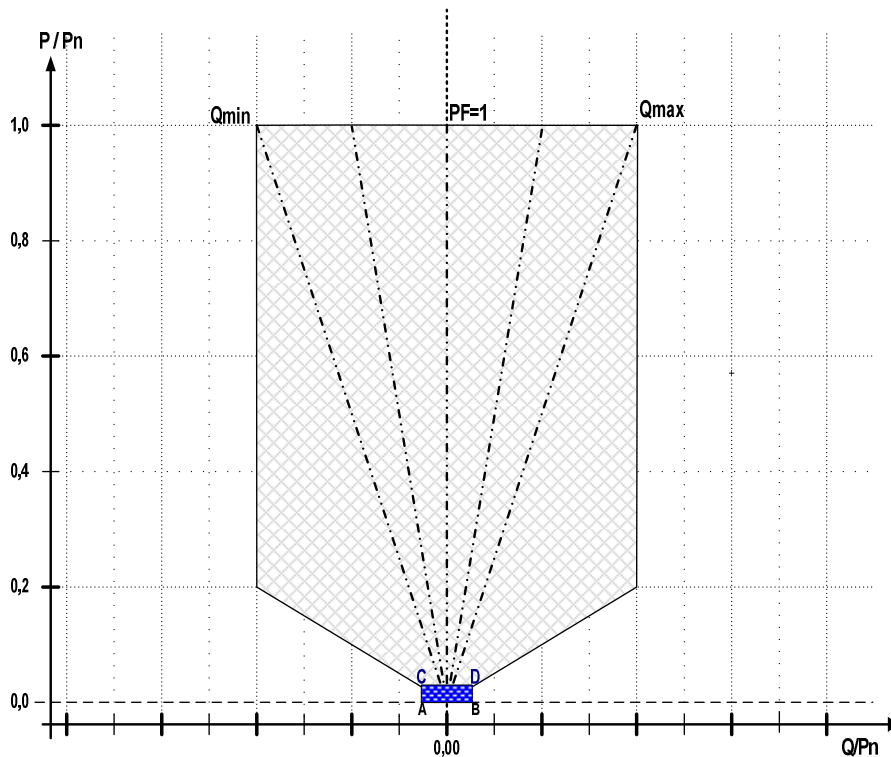

Figure 10a: Reactive power requirements for RPPs of category C at the POC ( $Q_{min}$  and  $Q_{max}$  are voltage dependent as defined by Figure 11)



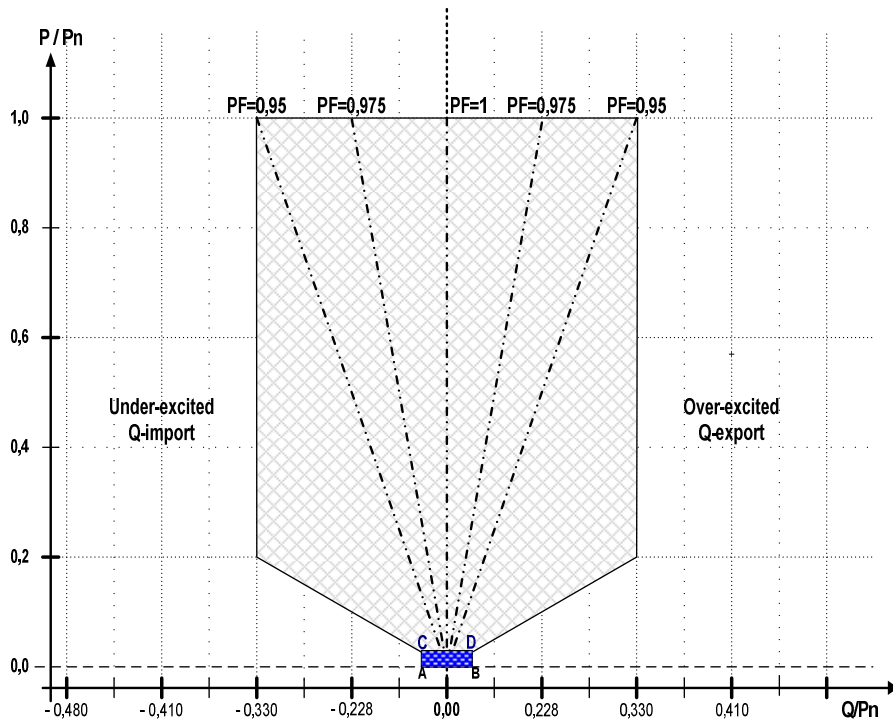

Figure 10b: Reactive power requirements for RPPs of category C (at nominal voltage at POC)

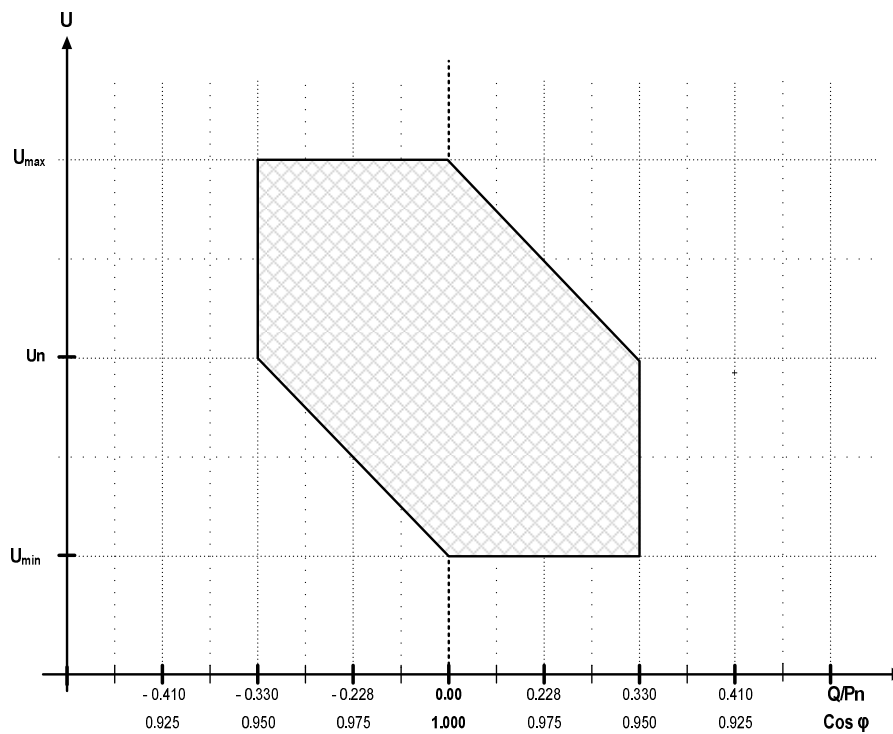

Figure 11: Requirements for reactive power and voltage control range for RPPs of category C

## 8. Reactive Power and Voltage Control Functions

- (1) The following requirements shall apply to *RPPs* of *category B and C*.
- (2) The *RPP* shall be equipped with reactive power control functions capable of controlling the reactive power supplied by the *RPP* at the *POC* as well as a voltage control function capable of controlling the voltage at the *POC* via orders using setpoints and gradients.
- (3) The reactive power and voltage control functions are mutually exclusive, which means that only one of the three functions mentioned below can be activated at a time.
  - (a) Voltage control
  - (b) Power Factor control
  - (c) Q control
- (4) The control function and applied parameter settings for reactive power and voltage control functions shall be determined by the *NSP* in collaboration with the *SO*, and implemented by the *RPP generator*. The agreed control functions shall be documented in the *operating agreement*.

### 8.1 Reactive power (Q) Control

- (1) Q control is a control function controlling the reactive power supply and absorption at the *POC* independently of the active power and the voltage. This control function is illustrated in **Figure 12** as a vertical line.
- (2) If the Q control setpoint is to be changed by the *NSP*, *SO* or their agent, the *RPP generator* shall update its echo analog set point value in response to the new value within two seconds. The *RPP* shall respond to the new set point within 30 seconds after receipt of an order to change the setpoint.
- (3) The accuracy of the control performed and of the setpoint shall not deviate by more than  $\pm 2\%$  of the setpoint value or by  $\pm 0.5\%$  of maximum reactive power, depending on which yields the highest tolerance.
- (4) The *RPP* shall be able to receive a Q setpoint with an accuracy of at least 1kVar.

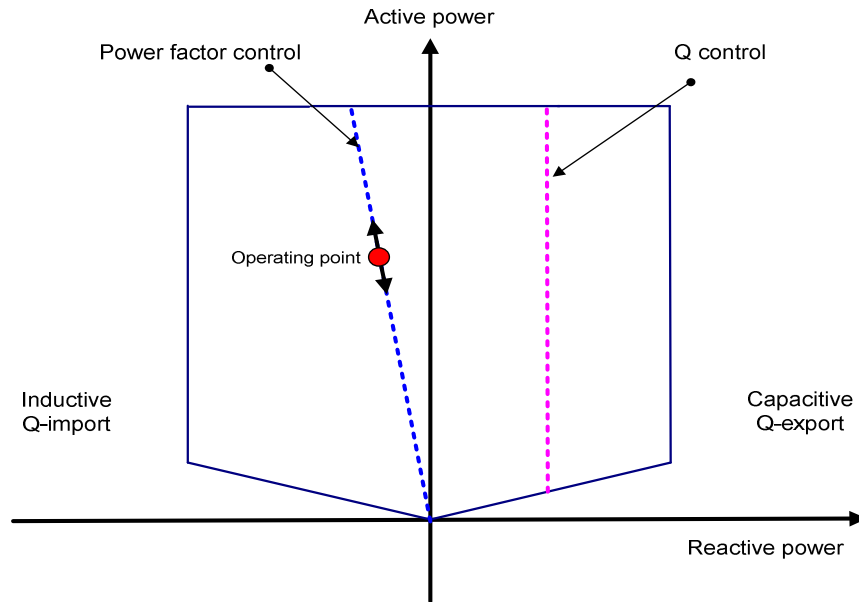

**Figure 12: Reactive power control functions for the RPP**

### 8.2 Power Factor Control

- (1) Power Factor Control is a control function controlling the reactive power proportionally to the active power at the POC. This is illustrated in **Figure 12** by a line with a constant gradient.
- (2) If the power factor setpoint is to be changed by the NSP, SO or their agent, the RPP shall update its echo analog set point value to in response to the new value within two seconds. The RPP shall respond to the new set point within 30 seconds after receipt of an order to change the setpoint.
- (3) The accuracy of the control performed and of the setpoint shall not deviate by more than  $\pm 0.02$ .

### 8.3 Voltage Control

- (1) Voltage control is a control function controlling the voltage at the POC.
- (2) If the voltage setpoint is to be changed, such change shall be commenced within two seconds and completed no later than 30 seconds after receipt of an order to change the setpoint.
- (3) The accuracy of the voltage setpoint shall be within  $\pm 0.5\%$  of nominal voltage, and the accuracy of the control performed shall not deviate by more than  $\pm 2\%$  of the required injection or absorption of reactive power according to *droop* characteristics as defined in **Figure 13**.

(4) The individual *RPP* shall be able to perform the control within its dynamic range and voltage limit with the *droop* configured as shown in **Figure 13**. In this context, *droop* is the voltage change (p.u.) caused by a change in reactive power (p.u.).

(5) When the voltage control has reached the *RPP*'s dynamic design limits, the control function shall await possible overall control from the tap changer or other voltage control functions.

(6) Overall voltage coordination shall be handled by the *NSP* in collaboration with the *SO*.

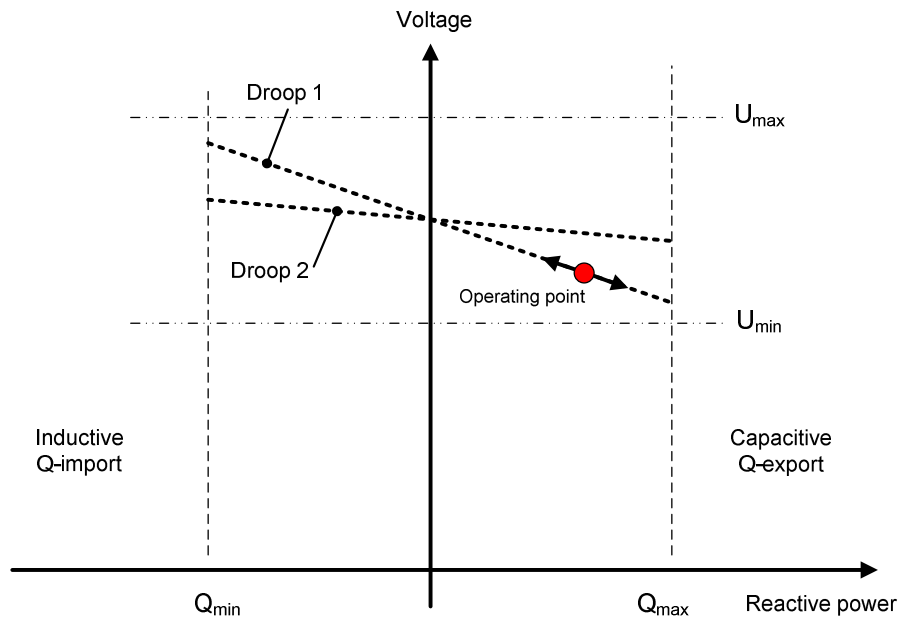

**Figure 13: Voltage control for the *RPP***

## **9. Power Quality**

(1) The following requirements shall apply to all *categories* of *RPPs*.

(2) *Power quality* and voltage regulation impact shall be monitored at the *POC* and shall include an assessment of the impact on *power quality* from the *RPP* concerning the following disturbances at the *POC*:

- (a) voltage fluctuations:
  - (i) rapid voltage changes
  - (ii) flicker
- (b) high-frequency currents and voltages:
  - (i) harmonics
  - (ii) inter-harmonics
  - (iii) disturbances greater than 2 kHz.

- (c) unbalanced currents and voltages:
  - (i) deviation in magnitude between three phases
  - (ii) deviation in angle separation from 120° between three phases.
- (d) *RPP* will generally follow the supply network frequency:
  - (i) Any attempt by the *RPP* to change the supply frequency may result in severe distortion of the voltage at the *POC*, *PCC* and other points in the network.

(3) Voltage and current quality distortion levels emitted by the *RPP* at the *POC* shall not exceed the apportioned limits as determined by the relevant *NSP*. The calculation of these emission levels shall be based on international and local specifications. The allocation shall be fair and transparent.

(4) The *RPP generator* shall ensure that the *RPP* is designed, configured and implemented in such a way that the specified emission limit values are not exceeded.

(5) Voltage changes under normal operating conditions shall be limited according to the values provided in **Table 3** below. These limits apply at the full range of fault levels at the *POC* of the *RPP* where full generation is possible.

**Table 3: maximum voltage change permitted at different voltage levels as a function of the frequency of these voltage changes.**

Number of changes per hour <i>r</i>	Percentage Change in the Voltage	
	nominal voltage at POC ≤44kV	nominal voltage at POC >44kV
<i>r</i> <1	4	3
1< <i>r</i> ≤10	3	2,5
10< <i>r</i> ≤100	2	1,5
100< <i>r</i> <1000	1,25	1

(6) The *RPP* can assume that the network harmonic impedance at the *POC* will be less than 3 times the base harmonic impedance for the range of reference fault levels at the *POC*, i.e. the network harmonic impedance shall not exceed a harmonic impedance of:

$$Z(h) = 3 * \frac{V^2}{S} * h$$

where *h* is the harmonic number, *V* is the nominal voltage in kV, and *S* is the fault level in MVA. The angle of the network harmonic impedance may range from fully inductive to fully capacitive.

(7) In order to assist with the maximum resonance of 3 times as per clause (6) above, no *RPP* may connect equipment, e.g. shunt capacitor banks, that will cause a resonance of more than 3 times at the *POC* at any frequency.

(8) The *Transmission and Distribution network service providers* shall use its reasonable endeavours to furnish the *RPP* with a reliable and continuous connection for the delivery of electrical energy up to the *POC*. The network operators do not guarantee that the continuity and voltage quality of the connection will always be maintained under all contingencies. It is therefore incumbent upon the *RPP* to take adequate measures to protect the *RPP* Facility against any losses and/or damage arising from frequency deviations, connection/supply interruptions, voltage variations (including voltage dips), voltage harmonics, interharmonics, voltage flicker, voltage unbalance, voltage swells and transients, undervoltages and overvoltages in the connection. It is also incumbent upon the *RPP* to take such necessary measures so as not to cause any damage to the *TS and DS*.

## **10. Protection and Fault levels**

- (1) Unless otherwise stated, requirements in this section apply to all *categories* of *RPPs*.
- (2) Protection functions shall be available to protect the *RPP* and to ensure a stable *TS* and *DS*.
- (3) The *RPP generator* shall ensure that a *RPP* is dimensioned and equipped with the necessary protection functions so that the *RPP* is protected against damage due to faults and incidents in the *TS* and *DS*.
- (4) The *RPP* of *category A* shall be equipped with effective detection of islanded operation in all system configurations and capability to shut down generation of power in such condition within 0.2 seconds. Islanded operation with part of the *TS* or *DS* is not permitted unless specifically agreed with the *NSP*.
- (5) The *RPP* of *category B* and *C* shall be equipped with effective detection of islanded operation in all system configurations and capability to shut down generation of power in such condition within 2 seconds. Islanded operation with part of the *TS* or *DS* is not permitted unless specifically agreed with the *NSP*.
- (6) The *NSP* or the *SO* may request that the set values for protection functions be changed following commissioning if it is deemed to be of importance to the operation of the *TS* and *DS*. However, such change shall not result in the *RPP* being exposed to negative impacts from the *TS* and *DS* lying outside of the design requirements.
- (7) The *NSP* shall inform the *RPP generator* of the highest and lowest short-circuit current that can be expected at the *POC* as well as any other information about the *TS* and *DS* as may be necessary to define the *RPP's* protection functions.

## 11. Active Power Constraint Functions

- (1) This section shall apply to *RPPs* of categories A3, B & C
- (2) For system security reasons it may be necessary for the *SO*, *NSP* or their agent to curtail the *RPP* active power output.
- (3) The *RPP generator* shall be capable of:
  - (a) operating the *RPP* at a reduced level if active power has been curtailed by the *SO*, *NSP* or their agent for network or system security reasons.
  - (b) receiving a telemetered *MW Curtailment set-point* sent from the *SO*, *NSP* or their agent. If another operator is implementing power curtailment, this shall be in agreement with all the parties involved.
- (4) The *RPP* shall be equipped with constraint functions, i.e. supplementary active power control functions. The constraint functions are used to avoid imbalances in the *NIPS* or overloading of the *TS* and *DS* in connection with the reconfiguration of the *TS* and *DS* in critical or unstable situations or the like, as illustrated in **Figure 14**.
- (5) Activation of the active power constraint functions shall be agreed with the *SO* or *NSP*. The required constraint functions are as follows:
  - (a) Absolute production constraint
  - (b) Delta production constraint
  - (c) Power gradient constraint
- (6) The required constraint functions are described in the following sections.

### 11.1 Absolute Production Constraint

- (1) An Absolute Production Constraint is used to constrain the output active power from the *RPP* to a predefined power MW limit at the *POC*. This is typically used to protect the *TS* and *DS* against overloading.
- (2) If the setpoint for the Absolute Production Constraint is to be changed, such change shall be commenced within two seconds and completed not later than 30 seconds after receipt of an order to change the setpoint.
- (3) The accuracy of the control performed and of the setpoint shall not deviate by more than  $\pm 2\%$  of the setpoint value or by  $\pm 0.5\%$  of the *rated power*, depending on which yields the highest tolerance.

## 11.2 Delta Production Constraint

- (1) A Delta Production Constraint is used to constrain the active power from the *RPP* to a required constant value in proportion to the possible active power.
- (2) A Delta Production Constraint is typically used to establish a control reserve for control purposes in connection with *frequency control*.
- (3) If the setpoint for the Delta Production Constraint is to be changed, such change shall be commenced within two seconds and completed no later than 30 seconds after receipt of an order to change the setpoint.
- (4) The accuracy of the control performed and of the setpoint shall not deviate by more than  $\pm 2\%$  of the setpoint value or by  $\pm 0.5\%$  of the *rated power*, depending on which yields the highest tolerance.

## 11.3 Power Gradient Constraint

- (1) A Power Gradient Constraint is used to limit the maximum ramp rates by which the active power can be changed in the event of changes in primary renewable energy supply or the setpoints for the *RPP*, taking into account the availability of primary energy to support these gradients. A Power Gradient Constraint is typically used for reasons of system operation to prevent changes in active power from impacting the stability of the *TS* or the *DS*.
- (2) If the setpoint for the Power Gradient Constraint is to be changed, such change shall be commenced within two seconds and completed no later than 30 seconds after receipt of an order to change the setpoint.
- (3) The accuracy of the control performed and of the setpoint shall not deviate by more than  $\pm 2\%$  of the setpoint value or by  $\pm 0.5\%$  of the *rated power*, depending on which yields the highest tolerance.
- (4) The active power constraint functions are illustrated on **Figure 14**.



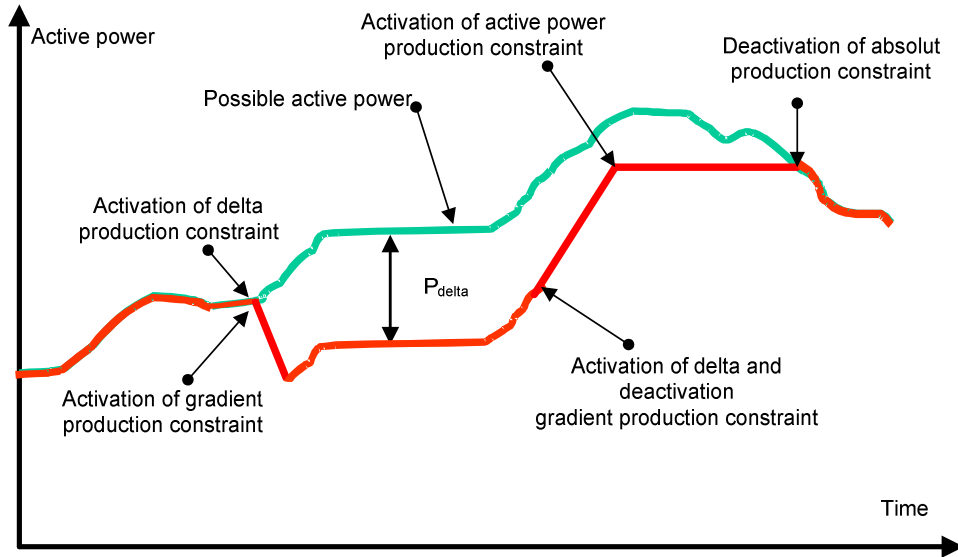

**Figure 14: Active power control functions for a Renewable Power Plant**

## 12. Control Function Requirements

- (1) *RPPs* shall be equipped with the control functions specified in **Table 4**. The purpose of the various control functions is to ensure overall control and monitoring of the *RPP's* generation.
- (2) The *RPP* control system shall be capable of controlling the ramp rate of its active power output with a maximum MW per minute ramp rate set by *SO* or *NSP*.
- (3) These ramp rate settings shall be applicable for all ranges of operation including positive ramp rate during start up, positive ramp rate only during normal operation and negative ramp rate during controlled shut down. They shall not apply to frequency regulation.
- (4) The *RPP generator* shall not perform any frequency response or voltage control functions without having entered into a specific agreement to this effect with the *NSP*.
- (5) The specifications and regulation functions specified shall comply with the international standard IEC 61400-25-2

**Table 4: Control functions required for RPPs**

<b>Control function</b>	<b>Category A3</b>	<b>Category B</b>	<b>Category C</b>
Frequency control	-	-	X
Absolute production constraint	X	X	X
Delta production constraint	-	-	X
Power gradient constraint	X	X	X
Q control	-	X	X
Power factor control	-	X	X
Voltage control	-	X	X

### **13. Signals, Communications & Control**

- (1) All signals shall be made available at the *POC* by the *RPP generator*.
- (2) Requirements for the exchange of signals between *RPPs of category A* and the *NSP* or *SO* shall be limited to a start and stop signals.
- (3) Requirements for the exchange of signals between *RPPs of category B and C*, and the *NSP*, *SO* or their agent are described in the following sections.

#### **13.1 Signals from the RPP available at the POC**

- (1) This section shall apply to *RPPs of category B and C*.
- (2) Signals from the *RPP* to the *SO* or *NSP* or their agent shall be broken up into a number of logical groups depending on functionality.
- (3) The following signal list groups shall apply:

**(a) Signals List #1 – General**

In addition, *RPPs* shall be required to provide certain signals from Signals Lists 2, 3, 4 and 5. These lists relate to:

- (b) Signals List #2 - RPP Availability Estimate;**
- (c) Signals List #3 - RPP MW Curtailment Data;**
- (d) Signals List #4 - Frequency Response System Settings;**

**(e) Signals List #5 - RPP Meteorological Data.**

**13.1.1 Signals List #1 – General**

- (1) The *RPP generator* shall make the following signals available at a *SO or NSP* designated *communication gateway equipment* located at the *RPP* site:
- (a) Actual sent-out (MW) at the *POC*
  - (b) Active Power Ramp rate of the entire *RPP*
  - (c) Reactive Power Import/Export (+/-Mvar) at the *POC*
  - (d) Reactive power range upper and lower limits
  - (e) *Power Factor*
  - (f) *Voltage output*
  - (g) *Echo MW set point*
  - (h) *Echo Mvar set point*
  - (i) *Echo Voltage set point*

**13.1.2 Signals List #2 – RPP Availability Estimates**

- (1) *RPP generator* shall make available the following signals at a *SO or NSP* designated *communication gateway equipment* located at the *RPP* site:
- (a) Available MW and forecast MW for the next 6 hours updated hourly on the hour.
  - (b) Available range of Mvar capability for the next 6 hours updated hourly on the hour.

**13.1.3 Signals List #3 – RPP MW Curtailment Data**

- (1) The *RPP generator* shall make the following signals available at a designated *communication gateway equipment* located at the *RPP* site:
- (a) *RPP* MW Curtailment facility status indication (ON/OFF) as a double bit point. This is a controllable point which is set on or off by the *SO*. When set “On” the *RPP* shall then clarify and initiate the curtailment based on the curtailment set point value below.
  - (b) Curtailment in progress digital feedback. This single bit point will be set high by the *RPP* while the facility is in the process of curtailing its output.
  - (c) *RPP* MW Curtailment Set-point value (MW- feedback).
- (2) In the event of a curtailment, the *SO* will pulse the curtailment set point value down. The *RPP* response to the changed curtailment value will be echoed by changing the

corresponding echo MW value. This will provide feedback that the *RPP* is responding to the curtailment request.

#### **13.1.4 Signals List #4 – Frequency Response System Settings**

(1) The *RPP generator* shall make the following signals available at a *SO* or *NSP* designated *communication gateway equipment* located at the *RPP* site:

- (a) *Frequency Response System* mode status indication (ON/OFF) as a double bit point

#### **13.1.5 Signals List #5 – RPP Meteorological Data.**

(1) *RPP generator* shall make the following signals available at a *SO* or *NSP* designated *communication gateway equipment* located at the *RPP* site:

- (a) Wind speed (within 75% of the hub height) – measured signal in meters/second (for *WPP only*)
- (b) Wind direction within 75% of the hub height) – measured signal in degrees from true north(0-359) (for *WPP only*)
- (c) Air temperature- measured signal in degrees centigrade (-20 to 50);
- (d) Air pressure- measured signal in millibar (800 to 1400).
- (e) Air density (for *WPP only*)
- (f) Solar radiation (for *PVPP only*)

(2) The meteorological data signals shall be provided by a dedicated Meteorological Mast located at the *RPP* site or, where possible and preferable to do so, data from a means of the same or better accuracy.

(3) Energy resource conversion data for the facility (e.g. MW/ wind speed) for the various resource inputs to enable the *SO* to derive a graph of the full range of the facilities output capabilities. An update will be sent to the *SO* following any changes in the output capability of the facility.

(4) For *RPP* where the *units* are widely dispersed over a large geographical area and rather different weather patterns are expected for different sections of the *RPP*, the meteorological data shall be provided from a number of individual Meteorological Masts, or where possible and preferable to do so, data from a source of the same or better reliability for groups of *units*. It is expected that *units* within an individual group shall demonstrate a high degree of correlation in Active Power output at any given time. The actual signals required shall be specified by the *SO*. There shall be at least one Meteorological Mast for every 10x10 square km area of the facility

### **13.2 Update Rates**

(1) Signals shall be updated at the following rates:

- (a) Analog Signals at a rate of 2 seconds.
- (b) Digital Signals at the rate of 1 second.
- (c) Meteorological data once a minute

### **13.3 Control Signals Sent from SO to the RPPs**

(1) The control signals described below shall be sent from *SO* to the *RPP*. The *RPP* shall be capable of receiving these signals and acting accordingly.

#### **13.3.1 Active-Power Control**

(1) An Active-Power Control set-point signal shall be sent by *SO* to the *RPP* control system. This set-point shall define the maximum Active Power output permitted from the *RPP*. The *RPP* control system shall be capable of receiving this signal and acting accordingly to achieve the desired change in Active Power output. See (a) in Figure 15 below

(2) This value is controlled by raise or lower pulses.

(3) The *RPP generator* shall make it possible for the *SO* to remotely enable/disable the Active-Power control function in the *RPP* control system.

#### **13.3.2 Connection Point CB Trip facility**

(1) A facility shall be provided by the *NSP* to facilitate the disconnection of the *RPP*. It shall be possible for *SO*, *NSP* or their agent to send a trip signal to the circuit breaker at the *HV* side of the *POC*. This is currently implemented via the breaker shown as (b) in Figure 15 below.

### **13.4 MW Forecast**

(1) This section applies only to *RPPs* of category *B* and *C*.

(2) The *RPP generator* shall have the capability to produce and submit to the *SO* the day-ahead and week-ahead hourly MW production forecast.

(3) The forecasts shall be provided by *RPP generator*. These forecasts shall be provided by 10:00 a.m. on a daily basis for the following 24 hours and 7 days for each 1 hour time-period, by means of an electronic interface in accordance with the reasonable requirements of *SO*'s data system.

### **13.5 RPP MW availability declaration**

(1) The *RPP generator* shall submit *RPP MW availability declarations* whenever changes in MW availability occur or are predicted to occur. These declarations shall be submitted by means of an electronic interface in accordance with the requirements of SO's data system.

### **13.6 Data Communications Specifications**

(1) The *RPP* shall have external *communication gateway equipment* that can communicate with a minimum of three simultaneous SCADA Masters, independently from what is done inside the *RPP*.

(2) The location of the *communication gateway equipment* shall be agreed between affected *participants* in the *connection agreement*.

(3) The necessary communications links, communications protocol and the requirement for analogue or digital signals shall be specified by the *SO* as appropriate before a *connection agreement* is signed between the *RPP generator* and the *Distributor* or *TNSP*.

(4) Active Power Curtailment or Voltage Regulation facilities at the *RPP* shall be tested once a month. It is essential that facilities exist to allow the testing of the functionality without tripping the actual equipment.

(5) Where signals or indications required to be provided by the *RPP generator* become unavailable or do not comply with applicable standards due to failure of the *RPP* equipment or any other reason under the control of the *RPP*, the *RPP generator* shall restore or correct the signals and/or indications within 24 hours.

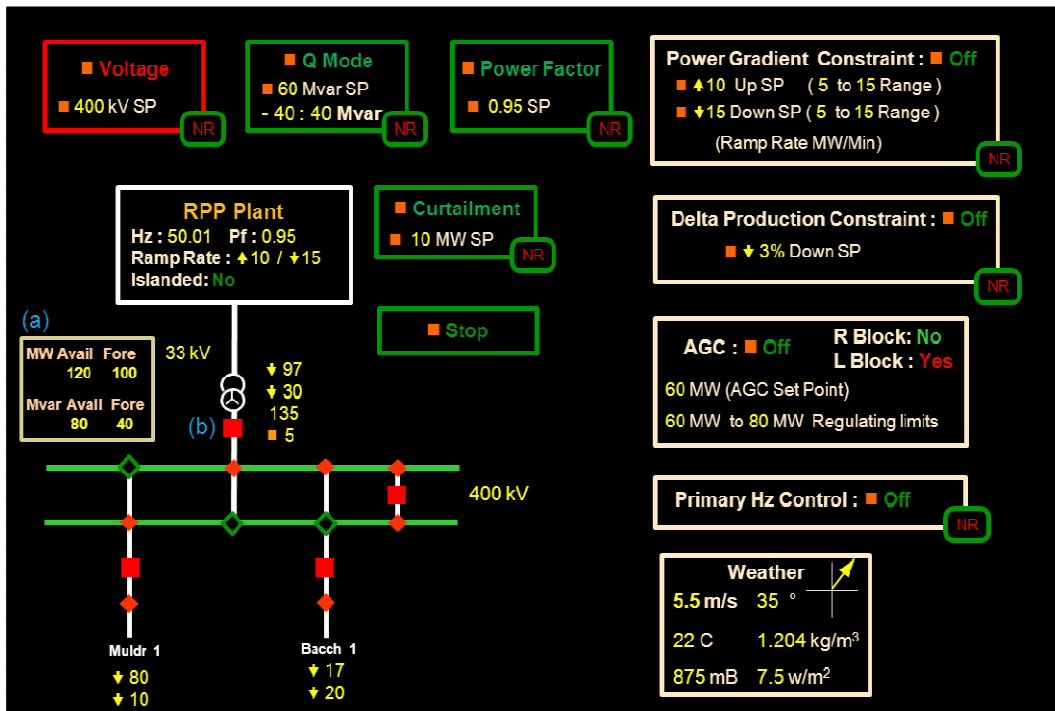

Figure 15: Example of one line Human Machine Interface layout

## 14. Testing and Compliance Monitoring

- (1) All *RPP generators* shall demonstrate compliance to all applicable requirements specified in this grid connection code and any other applicable *code* or standard approved by NERSA, as applicable, before being allowed to connect to the *DS* or the *TS* and operate commercially.
- (2) The *RPP generator* shall review, and confirm to the *SO and NERSA*, compliance by the *RPP* with every requirements of this code.
- (3) The *RPP generator* shall conduct tests or studies to demonstrate that the *RPP* complies with each of the requirements of this code.
- (4) The *RPP generator* shall continuously monitor its compliance in all material respects with all the connection conditions of this code.
- (5) Each *RPP generator* shall submit to the *SO* a detailed test procedure, emphasising system impact, for each relevant part of this code prior to every test.
- (6) If *RPP generator* determines, from tests or otherwise, that the *RPP* is not complying with one or more sections of this code, then the *RPP Generator* shall (within 1 hour of being aware):
  - (a) notify the *SO* of that fact

- (b) advise the *SO* of the remedial steps it proposes to take to ensure that the relevant *RPP* can comply with this code and the proposed timetable for implementing those steps
- (c) diligently take such remedial action to ensure that the relevant *RPP* can comply with this code; the *RPP generator* shall regularly report in writing to the *SO* on its progress in implementing the remedial action, and
- (d) after taking remedial action as described above, demonstrate to the reasonable satisfaction of the *SO* that the relevant *RPP* is then complying with this code.

(7) The *SO* may issue an instruction requiring the *RPP generator* to carry out a test to demonstrate that the relevant *RPP* complies with the code requirements. A *RPP generator* may not refuse such an instruction, provided it is issued timeously and there are reasonable grounds for suspecting non-compliance.

(8) The *RPP generator* shall keep records relating to the compliance of the *RPP* with each section of this grid connection code, or any other *code* applicable to that *RPP*, setting out such information that the *SO* reasonably requires for assessing power system performance, including actual *RPP* performance during abnormal conditions. Records shall be kept for a minimum of 5 years (unless otherwise specified in the *code*) commencing from the date the information was created.

## 15. Reporting to NERSA

(1) The *RPP generator* shall design the system and maintain records so that the following information can be provided to the *NERSA* on a monthly basis in an electronic spread sheet format:

- (a) Non-renewable/supplementary fuel used by the power plant as outlined under Supplementary Fuel Specification schedule of the PPA during the month.
- (b) Day ahead forecast output energy to the grid and hourly availability as specified in 13.4 and 13.5 above.
- (c) Actual hourly availability and output energy to the grid that occurred and the average primary resource for that hour (i.e. Wind speed for wind generators and solar radiation for solar generation)
- (d) Actual hourly electricity imports from all sources as applicable.
- (e) Direct monthly emissions per unit of electricity generated by the *RPP* (tCO<sub>2</sub>/kWh).
- (f) Any curtailed energy during the month.

(2) These reports are to be submitted before the 15<sup>th</sup> of the following month to [IPSreports@nersa.org.za](mailto:IPSreports@nersa.org.za)



(3) These reports should also include details of incidents relating any unavailability of the network which prevented the RPP from generating and any incidents where their right to self-dispatch was impinged upon where the PPA gives them a right to self-dispatch.

## 16. Provision of Data and Electrical Dynamic Simulation

### Models

(1) The *SO*, *Distributors* and *TNSPs* require suitable and accurate dynamic models, in the template specified by the requesting party applying for a connection to the *DS* or *TS*, in order to assess reliably the impact of the *RPP* proposed installation on the dynamic performance and security and stability of the power system.

(2) The required dynamic models must operate under *RMS* and *EMT* simulation to replicate the performance of the *RPP* facility or individual units for analysis of the following network aspects:

- (a) *RPP* impact on network voltage stability
- (b) *RPP* impact on *QOS* at *POC*
- (c) *RPP* switching transients impact on network performance
- (d) *RPP* impact on breakers *TRV* (Transient Recovery Voltage)
- (e) *RPP* impact on network insulation co-ordination requirements
- (f) *RPP* impact on network protection co-ordination
- (g) *RPP FRT* (Fault Ride Through) capability for different types of faults and positions
- (h) *RPP* response to various system phenomena such as:
  - (i) switching on the network
  - (ii) power swings
  - (iii) small signal instabilities

(3) Generic instead of type tested *EMT* models can be accepted on condition that they represent *RPP* performance with frequency spectrum from 0 to 1kHz with accuracy level better than  $\pm 5\%$ .

(4) *RPP* data exchange shall be a time-based process.

(a) **First stage** (during the application for connection)

(i) The following information shall be submitted by the *RPP generator* to the *SO and Distributor or TNSP*, as applicable:

- Physical location of the *RPP* (including the GPS coordinates)
- Site Plan
- Number of wind turbines or *units* to be connected
- MW output per turbine or *unit*

- Initial phase MW value
- Final phase MW value and timelines
- Any other information that the service provider may reasonably require

(ii) For the detailed *RPP* design, the *NSP* shall make available to the *RPP generator* or its agent at least the following information:

- *Point of Connection* and the *Point of Common Coupling* including the nominal voltages,
- Expected fault levels
- The *network service provider's* connection between the *Point of connection* and the *RPP*,
- The busbar layout of the *PCC* and *POC* substations,
- The portion of the network service provider's grid that will allow accurate and sufficient studies to design the *RPP* to meet the Grid Code. This information shall include:
  - Positive and zero sequence parameters of the relevant network service provider's transmission and distribution, transformers, reactors, capacitors and other relevant equipment
  - The connection of the various lines transformers, reactors and capacitors etc.

(b) **Second stage** (after detailed *RPP* designs have been completed but before commissioning the *RPP*).

(i) During this stage, the *RPP generator* shall provide information on:

- Selected *RPP* technology data.
- Fault ride through capability and harmonic studies test report
- Generic test model and dynamic modelling data per wind turbine or *unit* as from the type approval and tests result

(c) **Third stage** (after commissioning and optimisation of the *RPP*)

(i) During this stage, the *RPP generator* is compelled to provide information on:

- A validated *RPP* electrical dynamic simulation model using commissioning test data and measurements

- Test measurement data in the format agreed between the *RPP generator* and the *Distributor, NTC* or *SO*, as applicable.

(5) The dynamic modelling data shall be provided in a format as may be agreed between the *RPP generator* and the *Distributor, NTC* or *SO*, as applicable.

(6) In addition, the *RPP Generator* shall provide the *SO* with operational data as prescribed in **Appendix 8**.

# Appendices

## Appendix 1 - Wind

### A1.1 High Wind Curtailment

- (1) It shall be possible to continuously downward regulate the active power supplied by the *RPP* to an arbitrary value in the interval from 100% to at least 40% of the rated power. When downward regulation is performed, the shutting-down of individual wind turbine *generator* systems is allowed so that the load characteristic is followed as well as possible.
- (2) The wind power plant shall stay connected to the *TS and DS* at average wind speeds below a predefined cut-out wind speed. The cut-out wind speed shall as a minimum be 25 m/s, based on the wind speed measured as an average value over a 10-minute period. To prevent instability in the *TS and DS*, the wind power plant shall be equipped with an automatic downward regulation function making it possible to avoid a temporary interruption of the active power production at wind speeds close to the cut-out wind speed.
- (3) Downward regulation shall be performed as continuous or discrete regulation. Discrete regulation shall have a step size of maximum 25% of the rated power within the hatched area shown in **Figure 16**. When downward regulation is being performed, the shutting-down of individual wind turbine *generator* systems is allowed. The downward regulation band shall be agreed with the *NSP* upon commissioning of the wind power plant.

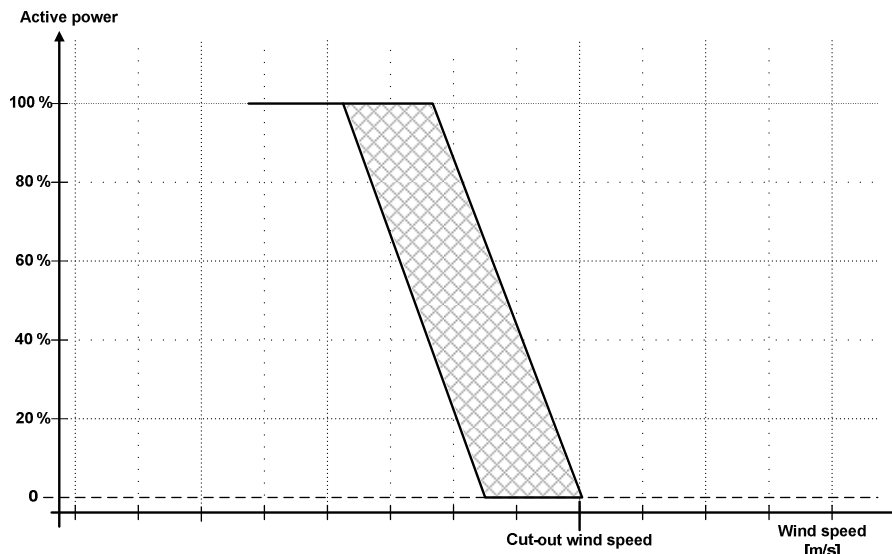

**Figure 16:** Downward regulation of active power at high renewable speeds

## **Appendix 2 - Photovoltaic**

No special requirements for solar PV except the general requirement specified in this code.

### **Appendix 3 - Concentrated Solar Power**

No special requirements for solar CSP except the general requirement specified in this code.

## **Appendix 4 - Small Hydro**

No special requirements for Small Hydro except the general requirement specified in this code.



## **Appendix 5 - Landfill Gas**

No special requirements for Landfill Gas except the general requirement specified in this code.

## **Appendix 6 - Biomass**

No special requirements for Biomass except the general requirement specified in this code.

## **Appendix 7 - Biogas**

No special requirements for Biogas except the general requirement specified in this code.

## Appendix 8 - Documentation

### A8.1 Master Data

Description	Text
<b>Identification:</b>	
Name of <i>electricity supply undertaking</i>	
Plant name	
ID number	
Planned commissioning	
<b>Technical data:</b>	
Manufacturer	
Type designation (model)	
Type approval	
Approval authority	
Installed kW ( <i>rated power</i> )	
Cos $\varphi$ ( <i>rated power</i> )	
Cos $\varphi$ ( <i>20% rated power</i> )	
Cos $\varphi$ ( <i>no load</i> )	
3-phase short-circuit current immediately in front of the <i>power plant</i> (RMS)	
<i>Point of connection</i>	
Voltage level	

Description	Text
<b>Plant address:</b>	
Contact person (technical)	
Address1	
House number	
Letter	
Postal code	
BBR municipality	
X/Y coordinates	
Title number	
Owners' association on titled land	
<b>Owner:</b>	
C ID number	
Company name	
Contact person (administrative)	
Address1	
House number	
Letter	
Floor	
To the right/left	
Postal code	
Email address	

## A8.2 Technical Documentation

### A8.2.1 Step-Up Transformer

Description	Value
Make	
Type	
Comments	

Description	Symbol	Unit	Value
Nominal apparent power (1 p.u.)	$S_n$	MVA	
Nominal primary voltage (1 p.u.)	$U_p$	kV	
Nominal secondary voltage	$U_s$	kV	
Coupling designation, eg Dyn11	-	-	
Step switch location	-	-	Primary side <input type="checkbox"/> Secondary side <input type="checkbox"/>
Step switch, additional voltage per step	$du_{tp}$	%/trin	
Step switch, phase angle of additional voltage per step:	$\phi_{i_{tp}}$	degree/st ep	
Step switch, lowest position	$n_{tpmin}$	-	
Step switch, highest position	$n_{tpmax}$	-	
Step switch, neutral position	$n_{tp0}$	-	
Short-circuit voltage, synchronous	$u_k$	%	
Copper loss	$P_{cu}$	kW	
Short-circuit voltage, zero system	$u_{k0}$	%	
Resistive short-circuit voltage, zero-sequence system	$u_{kr0}$	%	
No-load current	$I_0$	%	
No-load loss	$P_0$	%	

### A8.2.2 Single Line Diagram Representation

- (1) This applies to all *RPPs* of category B and C. The *SO, NSP or local network operator* may request that a single-line diagram representation be provided for *RPPs* of category A.
- (2) A single-line diagram representation of the plant shall be created, with indication of *POC*, metering points, including settlement metering, limits of ownership and operational supervisor limits/limits of liability. In addition, the type designation for the switchgear used shall be stated so as to make it possible to identify the correct connection terminals.
- (3) In instances when a single-line diagram representation is included in the grid use agreement between *RPP Generator* and *SO*, the *grid connection agreement* can be enclosed as documentation.

### A8.2.3 PQ Diagram

- (1) This applies to all *RPPs* of category B and C. The *SO, NSP or local network operator* may also request that a PQ diagram representation be provided for *RPPs* of category A.

### A8.2.4 Short-circuit data

**Application:** This applies to all *RPPs* of category B and C.

For the purposes of static calculations, the *RPP generator* shall provide short-circuit data at different voltage drops in the *TS and DS*, using the requirements in **section 5.2.1** as starting point. Voltage drops in connection with faults shall be stated with a short-circuit time of 150 ms.

The fault sequence is logged through simulation in the 0-500 ms time interval. Short-circuit data shall be provided in the following tables.

Assumptions for the calculation of short-circuit data:

- All *generator* in the *RPP* are connected
- The *RPP* produces *rated power*
- Current values are calculated in the *POC*
- Symmetrical voltage drop is indicated as a percentage (dU) of the output voltage
- The *RPP's* protection functions/settings are included
- The *short-circuit power* in the *POC* is set to  $10 \times P_n$  with an X/R of 10
- 50 Hz component of the active current,  $I_{\text{active}}$
- 50 Hz component of the reactive current,  $I_{\text{reactive}}$
- Total current incl. DC component and harmonics,  $I_{\text{peak}}$

dU=20%			
Time [ms]	$I_{\text{active}}$ [A]	$I_{\text{reactive}}$ [A]	$I_{\text{peak}}$ [A]
0			

5			
10			
20			
50			
100			
150			
200			
300			
500			

<b>dU=30%</b>			
Time [ms]	$I_{\text{active}}$ [A]	$I_{\text{reactive}}$ [A]	$I_{\text{peak}}$ [A]
0			
5			
10			
20			
50			
100			
150			
200			
300			
500			

<b>dU=50%</b>			
Time [ms]	$I_{\text{active}}$ [A]	$I_{\text{reactive}}$ [A]	$I_{\text{peak}}$ [A]
0			
5			
10			
20			
50			
100			
150			
200			
300			
500			

<b>dU=80%</b>			
Time [ms]	$I_{\text{active}}$ [A]	$I_{\text{reactive}}$ [A]	$I_{\text{peak}}$ [A]
0			
5			
10			
20			
50			
100			



150			
200			
300			
500			

## Appendix 9 – Compliance test specifications

### A9.1 Introduction

This section specifies the procedures to be followed in carrying out testing to verify compliance with this *Code*.

### A9.2 Test procedures

A9.2.1 - RPP protection function verification		
Parameter	Reference	Description
Protection function and settings	Section 10	<p><b>APPLICABILITY AND FREQUENCY</b> All new <i>RPPs</i> coming on line or at which major refurbishment or upgrades of protection systems have taken place.</p> <p><b>Routine review:</b> All <i>generators</i> to confirm compliance every six years.</p> <p><b>PURPOSE</b> To ensure that the relevant protection functions in the <i>RPP</i> are coordinated and aligned with the system requirements.</p> <p><b>PROCEDURE</b></p> <ol style="list-style-type: none"> <li>1. Establish the system protection function and associated trip level requirements from the <i>SO</i> or relevant <i>NSP</i>.</li> <li>2. Derive protection functions and settings that match the <i>RPP</i> and system requirements.</li> <li>3. Confirm the stability of each protection function for all relevant system conditions.</li> <li>4. Document the details of the trip levels and stability calculations for each protection function.</li> <li>5. Convert protection tripping levels for each protection function into a per <i>unit</i> base.</li> <li>6. Consolidate all settings in a per <i>unit</i> base for all protection functions in one document.</li> <li>7. Derive actual relay dial setting details and document the relay setting sheet for all protection functions.</li> <li>8. Document the position of each protection function on one single line diagram of the generating <i>unit</i> and associated connections.</li> <li>9. Document the tripping functions for each tripping function on one tripping logic diagram.</li> <li>10. Consolidate detail setting calculations, per unit setting sheets, relay setting sheets, plant base information on which the settings are based, tripping logic diagram, protection function single line diagram and relevant protection relay manufacturers' information into one document.</li> <li>11. Submit to the <i>SO</i> or relevant <i>NSP</i> for its acceptance and update.</li> </ol> <p><b>Review:</b></p> <ol style="list-style-type: none"> <li>1. Review Items 1 to 10 above.</li> <li>2. Submit to the <i>SO</i> or relevant <i>NSP</i> for its acceptance and update.</li> <li>3. Provide the <i>SO</i> or relevant <i>NSP</i> with one original master copy and one working copy.</li> </ol> <p><b>ACCEPTANCE CRITERIA</b> All protection functions are set to meet the necessary protection requirements of the <i>RPP</i> with a minimal margin,</p>

		optimal fault clearing times and maximum plant availability. Submit a report to the <i>SO</i> or relevant <i>NSP</i> one month after commissioning and six-yearly for routine tests.
--	--	---

A.9.2.2 - RPP protection integrity verification		
Parameter	Reference	Description
Protection integrity	Section 10	<p><b>APPLICABILITY AND FREQUENCY</b> All new <i>RPPs</i> coming on line and all other <i>power stations</i> after major works of refurbishment of protection or related plant. Also, when modification or work has been done to the protection, items 2 to 5 must be carried out. This may, however, be limited to the areas worked on or modified.</p> <p><b>Routine review:</b> All <i>RPPs</i> on: item 1 below: Review and confirm every 6 years Item 2, and 3 below: at least every 12 years.</p> <p><b>PURPOSE</b> To confirm that the protection has been wired and functions according to the specifications.</p> <p><b>PROCEDURE</b> 1. Apply final settings as per agreed documentation to all protection functions. 2. With the <i>unit</i> off load and de-energized, inject appropriate signals into every protection function and confirm correct operation and correct calibration. Document all protection function operations. 3. Carry out trip testing of all protection functions, from origin (e.g. Buchholz relay) to all tripping output devices (e.g. HV breaker). Document all trip test responses. 4. Apply short-circuits at all relevant protection zones and with <i>generator</i> at nominal speed excite <i>generator</i> slowly, record currents at all relevant protection functions and confirm correct operation of all relevant protection functions. Document all readings and responses. Remove all short-circuits. 5. With the <i>RPP</i> at nominal production. Confirm correct operation and correct calibration of all protection functions. Document all readings and responses.</p> <p><b>Review:</b> Submit to the <i>SO</i> or relevant <i>NSP</i> for its acceptance and update.</p> <p><b>ACCEPTANCE CRITERIA</b> All protection functions are fully operational and operate to required levels within the relay <i>OEM</i> allowable tolerances. Measuring instrumentation used shall be sufficiently accurate and calibrated to a traceable standard. Submit a report to the <i>SO</i> or relevant <i>NSP</i> one month after test.</p>

A9.2.3 - RPP active power control capability verification		
Parameter	Reference	Description
Active power control function and operational range	Section 11 depending on category	<p><b>APPLICABILITY</b> All new <i>RPPs</i> coming on line and after major modifications or refurbishment of related plant components or functionality.</p> <p><b>Routine test/reviews:</b> Confirm compliance every 6 years.</p> <p><b>PURPOSE</b> To confirm that the active power control capability specified is met.</p> <p><b>PROCEDURE</b> The following tests shall be performed within an active power level range of at least 0.2p.u. or higher</p> <ol style="list-style-type: none"> <li>1. The <i>RPP</i> will be required to regulate the active power to a set of specific setpoints within the design margins.</li> <li>2. The <i>RPP</i> will be required to obtain a set of active power setpoints within the design margins with minimum two different gradients for ramping up and two different gradients for ramping down.</li> <li>3. The <i>RPP</i> will be required to maintain as a minimum two different set levels of spinning reserve within the design margins.</li> <li>4. The <i>RPP</i> will be required to operate as a minimum to limit active power output according to two different absolute power constraint set levels within the design margins.</li> <li>5. The <i>RPP</i> will be required to verify operation according to as a minimum two different parameter sets for a frequency response curve within the design margins.</li> </ol> <p><b>ACCEPTANCE CRITERIA</b></p> <ol style="list-style-type: none"> <li>1. The <i>RPP</i> shall maintain the set output level within <math>\pm 2\%</math> of the capability registered with the <i>SO</i>, <i>NSP</i> or another <i>network operator</i> for at least one hour.</li> <li>2. The <i>RPP</i> shall demonstrate ramp rates with precision within <math>\pm 2\%</math> of the capability registered with the <i>SO</i>, <i>NSP</i> or another <i>network operator</i> for ramp up and down.</li> <li>3. The <i>RPP</i> shall maintain a spinning reserve set level within <math>\pm 2\%</math> of the capability registered with the <i>SO</i>, <i>NSP</i> or another <i>network operator</i> for at least one hour.</li> <li>4. The <i>RPP</i> shall maintain an absolute power constraint set level within <math>\pm 2\%</math> of the capability registered with the <i>System Operator</i> for at least one hour.</li> <li>5. The <i>RPP</i> shall demonstrate that the requested frequency response curves can be obtained.</li> </ol> <p>Submit a report to the <i>SO</i>, <i>NSP</i> or another <i>network operator</i> one month after the test.</p>

A9.2.4 - RPP reactive power control capability verification		
Parameter	Reference	Description
Reactive power control function and operational range	Sections 7 and 8 depending on category	<p><b>APPLICABILITY</b> All new <i>RPPs</i> coming on line and after major modifications or refurbishment of related plant components or functionality.</p> <p><b>Routine test/reviews:</b> Confirm compliance every 6 years.</p> <p><b>PURPOSE</b> To confirm that the reactive power control capability specified is met.</p> <p><b>PROCEDURE</b> The following tests shall be performed within a minimum active power level range of at least 0.2 p.u. or higher</p> <ol style="list-style-type: none"> <li>1. The <i>RPP</i> will be required to regulate the voltage at the PCC to a set level within the design margins.</li> <li>2. The <i>RPP</i> will be required to provide a fixed Q to a set level within the design margins.</li> <li>3. The <i>RPP</i> will be required to obtain a fixed PF within the design margins.</li> </ol> <p><b>ACCEPTANCE CRITERIA</b></p> <ol style="list-style-type: none"> <li>1. The <i>RPP</i> shall maintain the set voltage within <math>\pm 5\%</math> of the capability registered with the <i>SO, NSP</i> or another <i>network operator</i> for at least one hour.</li> <li>2. The <i>RPP</i> shall maintain the set Q within <math>\pm 2\%</math> of the capability registered with the <i>SO, NSP</i> or another <i>network operator</i> for at least one hour.</li> <li>3. The <i>RPP</i> shall maintain the set PF within <math>\pm 2\%</math> of the capability registered with the <i>SO, NSP</i> or another <i>network operator</i> for at least one hour.</li> </ol> <p>Submit a report to the <i>SO, NSP</i> or another <i>network operator</i> one month after the test.</p>

A9.2.5 - RPP power quality calculations		
Parameter	Reference	Description
Power quality calculations for:  1. Rapid voltage changes  2. Flicker  3. Harmonics  4. Inter-harmonics  5. High frequency disturbances	Section 9 depending on category	<p><b>APPLICABILITY</b> All new <i>RPPs</i> coming on line and after major modifications or refurbishment of related plant components or functionality.</p> <p><b>Routine test/reviews:</b> Confirm compliance every 6 years.</p> <p><b>PURPOSE</b> To confirm that the limits for all power quality parameters specified is met.</p> <p><b>PROCEDURE</b> The following tests shall be calculated within a minimum active power level range from 0.2p.u. to 1.0p.u.            1. Calculate the levels for rapid voltage changes are within the limits specified over the full operational range.            2. Calculate the flicker levels are within the limits specified over the full operational range.            3. Calculate the harmonics are within the limits specified over the full operational range.            4. Calculate the interharmonics are within the limits specified over the full operational range.            5. Calculate the disturbances higher than 2 Hz are within the limits specified over the full operational range.</p> <p><b>ACCEPTANCE CRITERIA</b>            1. The calculations shall demonstrate that the levels for rapid voltage changes are within the limits specified over the full operational range.            2. The calculations shall demonstrate that the flicker levels are within the limits specified over the full operational range.            3. The calculations shall demonstrate that the harmonics are within the limits specified over the full operational range.            4. The calculations shall demonstrate that the interharmonics are within the limits specified over the full operational range.            5. The calculations shall demonstrate that the disturbances higher than 2 Hz are within the limits specified over the full operational range</p> <p>Submit a report to the <i>System Operator</i> one month after the test.</p>

A.9.2.6 - RPP fault ride through simulations		
Parameter	Reference	Description
Simulations of fault ride through voltage droops and peaks.	Section 5.2.1 for category B and C	<p><b>APPLICABILITY</b> All new <i>RPPs</i> coming on line and after major modifications or refurbishment of related plant components or functionality.</p> <p><b>Routine test/reviews:</b> None.</p> <p><b>PURPOSE</b> To confirm that the limits for all power quality parameters specified is met.</p> <p><b>PROCEDURE</b> By applying the electrical simulation model for the entire RPP it shall be demonstrated that the RPP performs to the specifications.</p> <ol style="list-style-type: none"> <li>1. Area A - the RPP shall stay connected to the network and uphold normal production.</li> <li>2. Area B - the RPP shall stay connected to the network. The RPP shall provide maximum voltage support by supplying a controlled amount of reactive power within the design framework offered by the technology, see Figure 5.</li> <li>3. Area C - the RPP is allowed to disconnect.</li> <li>4. Area D - the RPP shall stay connected. The RPP shall provide maximum voltage support by absorbing a controlled amount of reactive power within the design framework offered by the technology, see Figure 5.</li> </ol> <p><b>ACCEPTANCE CRITERIA</b> 1. The dynamic simulations shall demonstrate that the RPP fulfils the requirements specified.</p> <p>Submit a report to the <i>SO, NSP or another network operator</i> three month after the commission.</p>